

RX³ RCCBs
4P up to 63A

Cat. N°(s): 4 020 62, 63, 64, 66, 67, 68, 70, 71, 72, 74, 75,
4 020 76

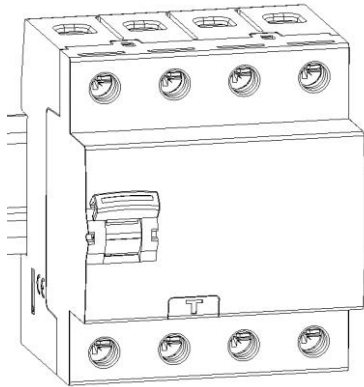

CONTENTS	PAGE
1. Description, use.....	1
2. Range	1
3. Overall dimensions.....	1
4. Preparation - Connection.....	1
5. General characteristics.....	3
6. Compliance and approvals	6
7. Curves.....	7
8. Auxiliaries and accessories	9
9. Safety.....	9

1. DESCRIPTION - USE

RCCBs with positive contact indication for control, protection and isolation of electrical circuits, protecting people from direct and indirect contact and protecting installations from insulation faults.

Symbol:

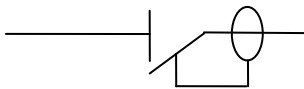

Technology:

. Electromagnetic residual current function with current-sensing relay

2. RANGE

Poles:

. 4-pole

Width:

. 4 modules (4 x 17.8 mm)

Rated currents:

. 25 / 40 / 63 A

Residual current types:

- . AC (sinusoidal differential alternating currents)
- . A (residual currents with a DC component)

Sensitivity:

. 30 / 100 / 300 mA

Rated voltage and frequency:

. 400 V~ / 415 V~, 50 Hz with standard tolerances

Maximum operating voltage:

. 440 V ~, 50 Hz

3. OVERALL DIMENSIONS

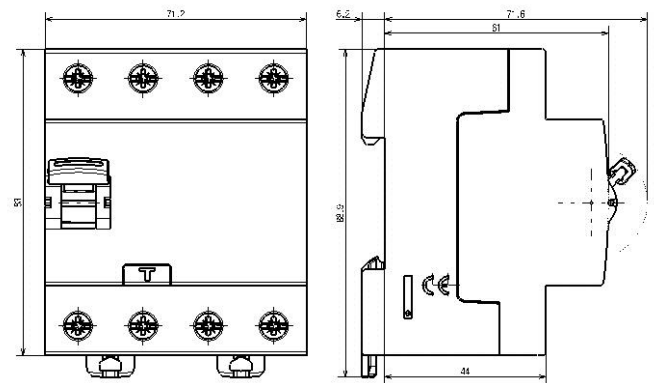

4. PREPARATION - CONNECTION

Mounting:

. On symmetrical rail EN 60715 or DIN 35 rail

Operating positions:

- . Vertical
- . Horizontal
- . Upside down
- . On the side

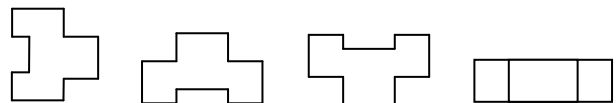

Power supply:

. From the top or the bottom

Connection:

- . Inputs and outputs via screw terminals
- . Neutral on right side
- . Cage terminals, with disengageable and captive screws
- . Terminals protected against direct finger contact IP20, wired

4. PREPARATION - CONNECTION *(continued)*

Connection: *(continued)*

- . Alignment and spacing of the terminals enabling to supply the products via prong supply busbars
- . Terminal depth: 14 mm
- . Terminal capacity: 60 mm²
- . Screw head: mixed head, slotted head and Philips / Pozidriv no. 2
- . Tightening torques:
 - Minimum / Maximum: 1.2 Nm / 3.5 Nm
 - Recommended: 2.5 Nm

Type of wire:

- . Copper cables at the top and bottom of the product
 - Cable cross-section:

	Without ferrule	With ferrule
Rigid cable	1 x 0.75 to 50 mm ² or 2 x 0.75 to 16 mm ²	/
Flexible cable	1 x 0.75 to 35 mm ² or 2 x 0.75 to 16 mm ²	1 x 0.75 to 25 mm ²

Tools required:

- . For the terminals:
 - 5.5 mm / 6.5 mm blade screwdriver recommended
 - Pozidriv n°2 / Philips N°2 screwdriver recommended
- . For the latching:
 - 5.5 mm blade screwdriver recommended / 6 mm maximum
 - Pozidriv n°2 / Philips N°2 screwdriver recommended

Manual actuation:

- . Manual action via ergonomic 2 position handle:
 - I-On, device closed
 - O-Off, device open

Contact status display:

- . By marking of the product:
 - I-On : closed contacts
 - O-Off : contacts open

Residual current tripping display:

- . Handle at the bottom position, the residual current is released

Lockout:

- . Possible in the open or closed positions with padlock support (Cat. No. 4 063 03) and Ø5 mm padlock (Cat. No. 4 063 13) or Ø6 mm padlock (Cat. No. 0 227 97)

Sealing:

- . Possible in the open or closed positions

RX³ RCCBs

4P up to 63A

Cat. N°(s): 4 020 62, 63, 64, 66, 67, 68, 70, 71, 72, 74, 75,
4 020 76

5. GENERAL CHARACTERISTICS

Neutral earthing system:

- . IT, TT and TN

Marking:

- . "N" marking of the neutral
- . Marking on the "front side": (by permanent ink pad)

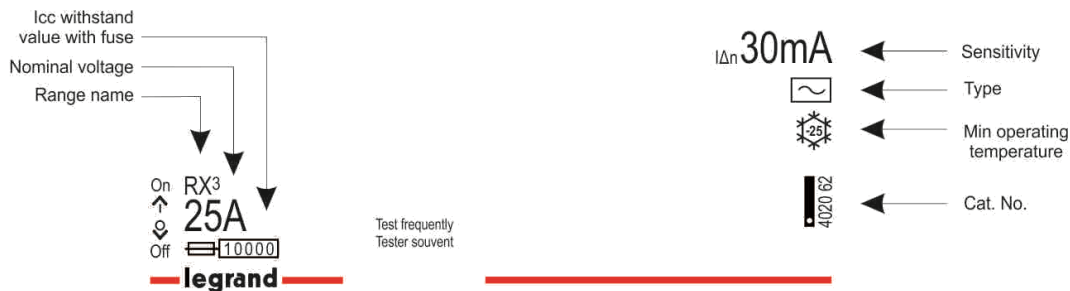

printing)

- . "N" marking of the neutral close to terminal screw

Marking on the upper side:

- . By permanent ink pad printing



Test operating voltage:

- . 30 mA AC/A types: from 320 V to 440 V~
- . 100 mA AC type: from 220 V to 440 V~
- . 300 mA AC type: from 220 V to 440 V~

Rated conditional short-circuit current:

- . $I_{nc} = 10$ kA, in accordance with EN/IEC 61008-1

Rated conditional short-circuit residual current:

- . $I_{\Delta c} = 10$ kA, in accordance with EN/IEC 61008-1

Rated residual breaking capacity:

- . $I_{\Delta m} = 1000$ A, in accordance with EN/IEC 61008-1

Rated breaking and making capacity:

In accordance with EN/IEC 61008-1,

- . $I_n = 25 / 40$ A : $I_m = 500$ A
- . $I_n = 63$ A : $I_m = 630$ A

Protection against overloads:

- . The RCCB must be protected against overloads (either upstream or downstream) by a circuit breaker or a fuse which has a maximum of the same nominal current as the residual current switch

RX³ RCCBs

4P up to 63A

Cat. N°(s): 4 020 62, 63, 64, 66, 67, 68, 70, 71, 72, 74, 75,
4 020 76

5. GENERAL CHARACTERISTICS (continued)

Protection against short-circuits:

. The RCCB must be protected upstream against short circuits using a circuit breaker or a fuse. Its resistance to short circuits when associated with a Legrand circuit breaker or fuse is compliant with the values stated in the tables below.

. Association with a fuse:

Downstream	Upstream			
RCCB	gG or aM type fuse			
Rating	≤ 50 A	63 A	80 A	≥ 100 A
25 A to 63 A	100 kA	50 kA	15 kA	10 kA

. Association with a circuit breaker:

Downstream RCCB	Upstream circuit breaker	
		RX ³ 6000
	Curve C	
	I _n ≤ 63 A	
25 A to 63 A	6 kA	

Temperature derating:

. Reference temperature: 30°C in accordance with standard IEC/EN 60947-2

I _n (A)	Ambient Temperature/I _n								
	- 25°C	- 10°C	0°C	10°C	20°C	30°C	40°C	50°C	60°C
25 A	25	25	25	25	25	25	25	25	25
40 A	40	40	40	40	40	40	40	25	25
63 A	63	63	63	63	63	63	63	40	40

Dissipated power:

RCCB		Total power dissipated by a 4 poles RCCBs (I _n)	
Rating	Sensitivity	AC type	A type
25 A	30 mA	6 W	6 W
25 A	100 mA	1,9 W	
25 A	300 mA	1,9 W	
40 A	30 mA	15,3 W	15,3 W
40 A	100 mA	4,8 W	
40 A	300 mA	4,8 W	
63 A	30 mA	11,8 W	11,8 W
63 A	100 mA	11,8 W	
63 A	300 mA	11,8 W	

Isolation distance (distance between the contacts) :

. Handle in open position - O-Off:

- Neutral pole: greater than 4.5 mm
- Phase pole: greater than 5.5 mm

RX³ RCCBs

4P up to 63A

Cat. N°(s): 4 020 62, 63, 64, 66, 67, 68, 70, 71, 72, 74, 75, 4 020 76

5. GENERAL CHARACTERISTICS *(continued)*

Rated insulation voltage:

. $U_i = 500 \text{ V}$

Insulation resistance:

. $2 \text{ M}\Omega$

Degree of pollution:

. 2

Dielectric strength:

. $2000 \text{ V} - 50 \text{ Hz}$

Impulse withstand voltage:

. $U_{imp} = 4 \text{ kV}$

Protection from unwanted tripping:

. $0.5 \mu\text{s}/100 \text{ kHz}$ damped recurring wave = 200 A
 . $8/20 \mu\text{s}$ wave: type = 250 A for both AC and A types

Protection classes:

. Terminals protected against direct contact: IP20 (wired device)
 . Front side protected against direct contact: IP40
 . Class II in relation to metallic conductive parts
 . Protection against impacts: IK04

Plastic materials used:

. Parts made of polyamide and P.B.T.

Enclosure heat and fire resistance:

. Resistance to glow wire tests at 960°C , in accordance with standard IEC/EN 61008-1
 . Classification V2, in accordance with standard UL94

Device's upper heating value:

. Estimated heating value of a 40A 30mA AC device : 4.30 MJ

Handle opening and closing forces:

. Force of 42 N for closing - (all ratings)
 . Force of 13 N for opening - (all ratings)

Mechanical endurance:

. Conforms to standard EN 61008-1
 . Tested with 20,000 operations with no load

Electrical endurance:

. Conforms to standard EN 61008-1
 . Tested with 10,000 operations with load (at $I_n \times \cos \varphi 0.9$)
 . Tested with 2,000 residual current tripping operations using the test button or the fault current

DC operation:

. Cannot be used with DC

Operation at 400 Hz:

. Cannot be used at 400 Hz

Operation at 60 Hz:

. Can be used at 60Hz, except ratings 40A/63A, A and AC types, with sensitivity 30mA.

5. GENERAL CHARACTERISTICS *(continued)*

Operating ambient temperature:

. $-25^\circ\text{C} / +60^\circ\text{C}$

Storage ambient temperature:

. $-40^\circ\text{C} / +70^\circ\text{C}$

Volume and packaging:

	Volume (dm ³)	Packaging
For all catalogue numbers	0.70	per unit

Weight:

Catalogue Number	Description	Weight (kg)
4 020 62	25 A AC type 30 mA	0.34
4 020 63	40 A AC type 30 mA	0.34
4 020 64	63 A AC type 30 mA	0.36
4 020 66	25 A AC type 100 mA	0.32
4 020 67	40 A AC type 100 mA	0.32
4 020 68	63 A AC type 100 mA	0.32
4 020 70	25 A AC type 300 mA	0.32
4 020 71	40 A AC type 300 mA	0.32
4 020 72	63 A AC type 300 mA	0.32
4 020 74	25 A A type 30 mA	0.33
4 020 75	40 A A type 30 mA	0.33
4 020 76	63 A A type 30 mA	0.36

Derating of RCCBs in terms of the number of devices installed side by side:

When several RCCBs are installed side by side and operate simultaneously, the heat dissipation of one pole is limited. This result is an increased operating temperature for the RCCBs. Applying the following coefficients to the operating currents is recommended.

Number of circuit breakers side by side	Coefficient
2 - 3	0.9
4 - 5	0.8
6 - 9	0.7
≥ 10	0.6

These values are provided by recommendation IEC 60439-1 and the standards NF C 63421 and EN 60439-1.

In order to avoid having to use these coefficients there must be good ventilation and the devices must be kept apart using the spacing elements Cat. No. 4 063 07 (0.5 module).

5. GENERAL CHARACTERISTICS *(continued)*

Impact of height:

	2000 m	3000 m	4000 m	5000 m
Dielectric strength	2000 V	2000 V	2000 V	1500 V
Maximum operating voltage	400 V	400 V	400 V	400 V
Derating at 30°C	none	none	none	none

Specific use:

- . Appropriate to operate in humid atmosphere and polluted by a chlorined environment (pool-type)

Resistance to sinusoidal vibrations: (in accordance with IEC 68.2.6)

- . Axis: x / y / z
- . Frequency: 10 to 55 Hz
- . Acceleration: 3 g (1 g = 9.81 m.s⁻²)

Resistance to tremors :

- . Conforms to standard EN 61008-1

6. COMPLIANCE AND APPROVALS

Reference product standards:

- . EN 61008-1/IEC 61008-1
- . EN/IEC 60 529 (IP)

Environment:

- . Compliance with European Union Directives
- . Compliance with Directive 2002/95/EC of 27/01/03 known as "RoHS" which provides for a restriction on the use of dangerous substances such as lead, mercury, cadmium, hexavalent chromium and polybrominated biphenyl (PBB) and polybrominated diphenyl ether (PBDE) brominated flame retardants from 1st July 2006
- . Compliance with the Directive 91/338/EEC of 18/06/91 and decree 94-647 of 27/07/94

Usage in special conditions:

- . Category C compliant (testing temperature of -25°C to +70°C, resistant to salt spray) in accordance with the classification defined in Appendix Q of standard IEC/EN 60947-1

Plastic materials:

- . Zero halogen plastic materials.
- . Labelling compliant with ISO 11469 and ISO 1043.

Packaging:

- . Design and manufacture of packaging compliant with decree 98-638 of 20/07/98 and Directive 94/62/EC

7. CURVES

Tripping current curves:

. Tripping time curve depending on the value of the fault current:

AC TYPE

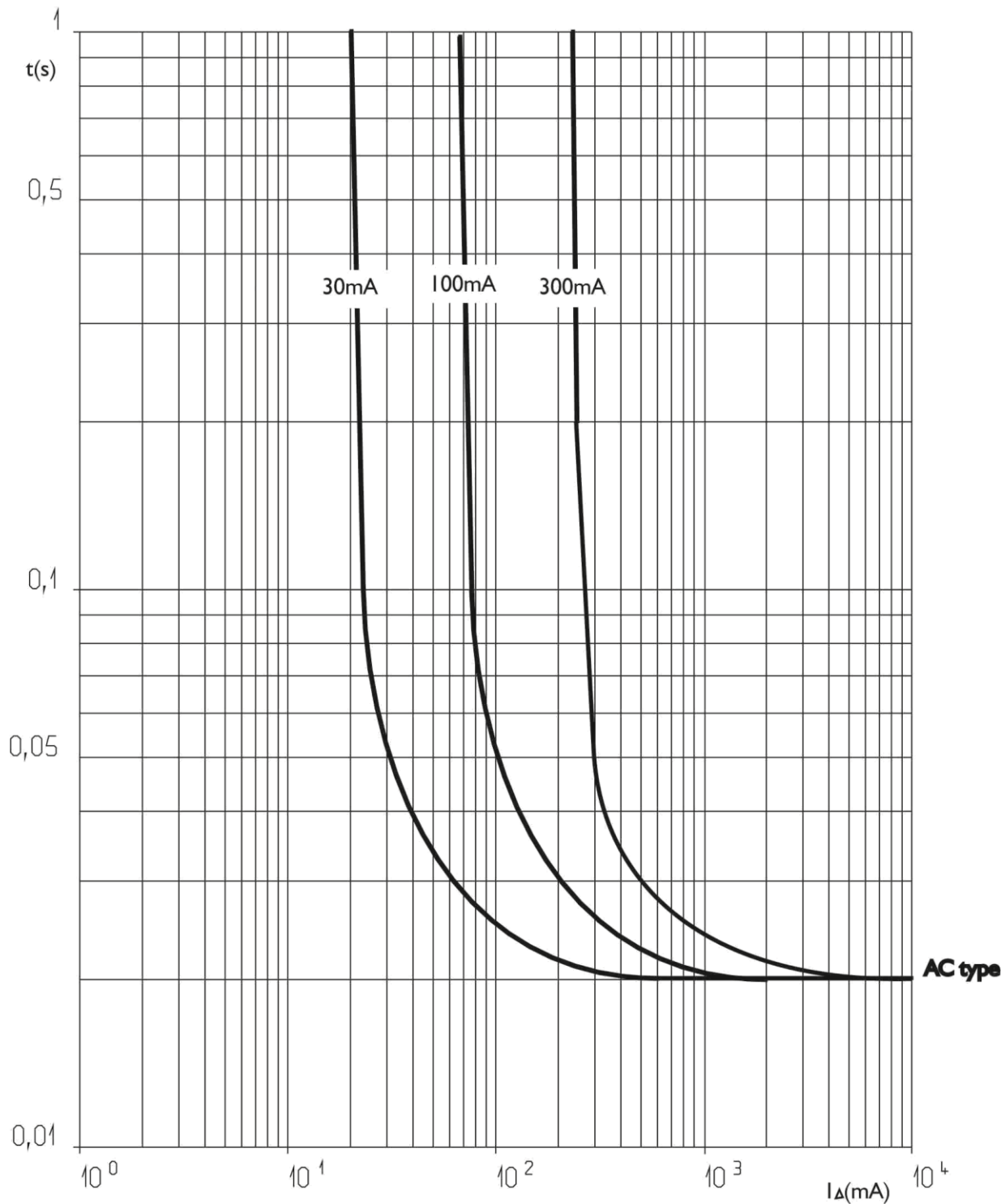

7. CURVES (continued)

Tripping current curves:

. Tripping time curve depending on the value of the fault current:

A TYPE

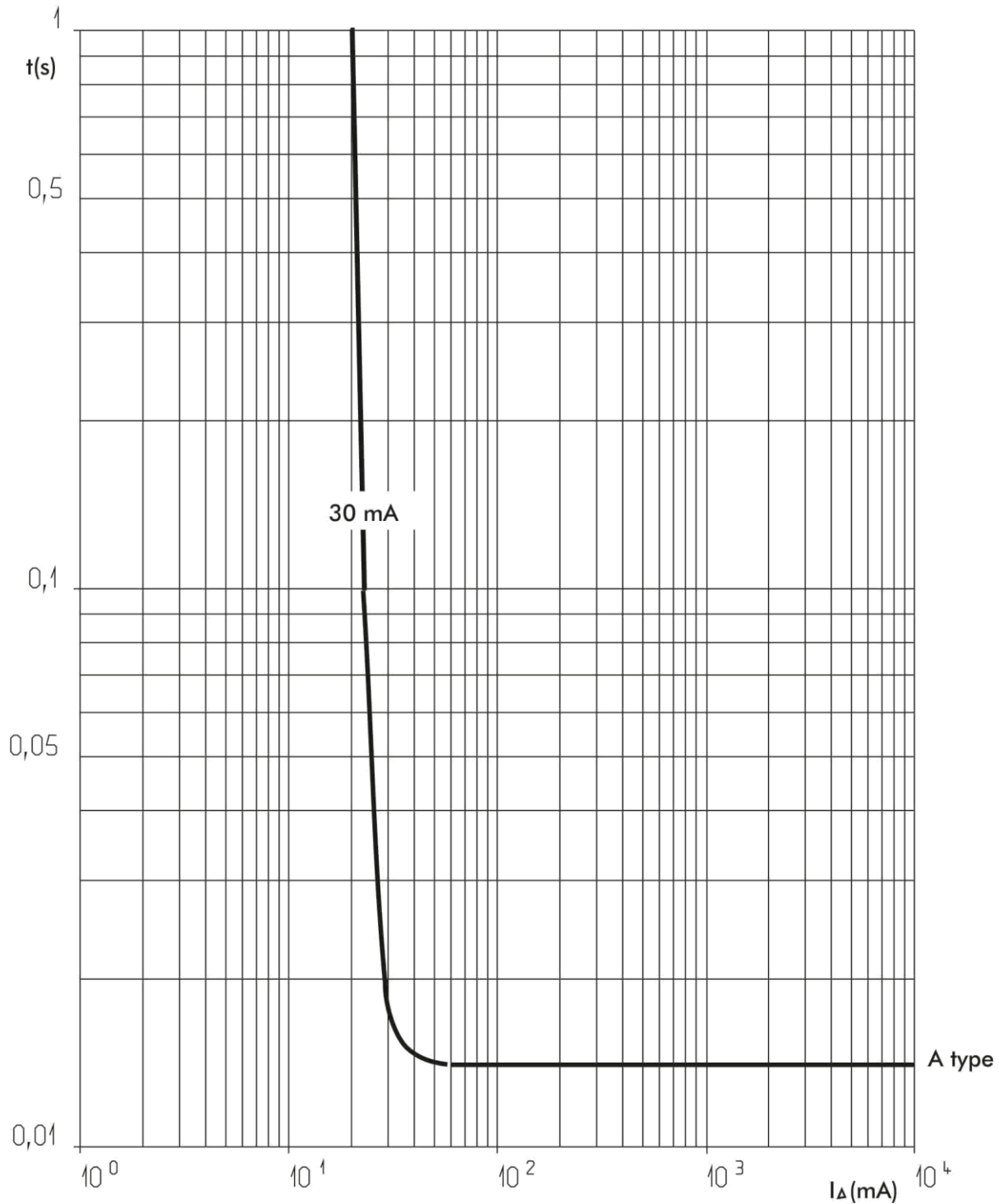

8. AUXILIARIES AND ACCESSORIES

Wiring accessories:

- . Sealable screw cover (Cat. No. 4 063 04)

Sealing:

- . Possible in the open or closed positions

Lockout possibilities:

- . Via Ø 5 mm padlock (Cat. No. 4 063 13) or Ø 6 mm padlock (Cat. Nos. 0 227 97) and padlock support (Cat. No. 4 063 03)

9. SAFETY

. For your safety your electrical installation is equipped with residual current protection and this must be tested periodically. In the absence of any national regulations on the time period required for this, Legrand recommends that this test be carried out every month: press the "T" test button, the device should trip. Please call an electrician immediately if this does not happen as your installation's safety level has been reduced

. The presence of residual current protection does not remove the need to observe all the precautions associated with using electrical energy