

16 A and 25 A power contactors with or without handle

Catalogue number(s): 4 125 03 / 04 / 05 / 09 / 10 / 14 / 17 / 21 / 22 / 23 / 24 / 33 / 34 / 35 / 36 / 44 / 51 and 927 02 / 03



CONTENTS	PAGES
1. Description, use.....	1
2. Range.....	1
3. Dimensions.....	1
4. Positioning - Connection.....	2
5. General characteristics.....	3
6. Equipment and accessories.....	6
7. Compliance and Approvals.....	7

1. DESCRIPTION - USE

Symbol:

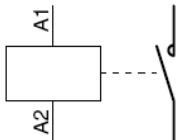

Technology:

- . Electromagnetic contactor (monostable relay)

Use:

- . For controlling a load remotely via a switch

2. RANGE

Conventional thermal current:

- . I_{th} = 16 and 25 A

Types of contact:

- . "NO" contact
- . "NC" contact
- . "NO + NC" mixed contact

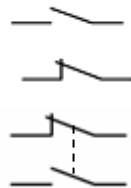

Polarities:

- . 2-pole in 1 module (17.8 mm)
 - "2NO"
 - "2NC"
 - "NO+NC"
- . 4-pole in 2 modules (35.6 mm)
 - "4NO"
 - "4NC"
 - "2NO + 2NC"
 - "3NO + 1 NC"

2. RANGE (continued)

Nominal voltage of the power circuit:

- . Un = 250 V/400 V~

Nominal voltage of the power circuit:

- . 24 V and 230 V~

Nominal frequency of the control and power circuits:

- . 50/60 Hz

3. DIMENSIONS

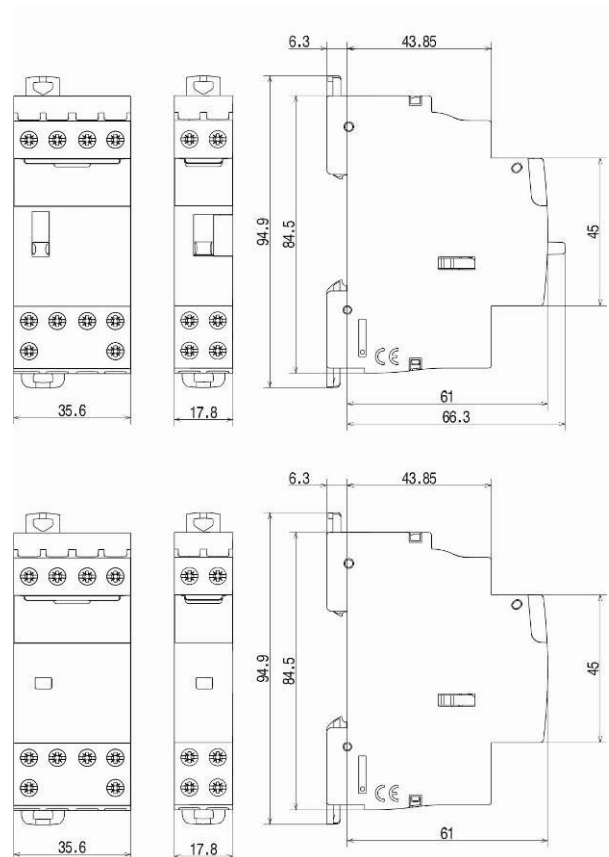

16A and 25A power contactors with or without handle

Catalogue number(s): 4 125 03 / 04 / 05 / 09 / 10 / 14 / 17 / 21 / 22 / 23 / 24 / 33 / 34 / 35 / 36 / 44 / 51 and 927 02 / 03

4. POSITIONING - CONNECTION

Installation software:

. XL PRO

Operating position:

. Vertical, horizontal, flat (all positions)

Mounting:

. On symmetrical EN 50-055 rail or DIN 35 rail, using two plastic clips.

Recommended tools:

. For the terminal screws: insulated or non-insulated screwdriver, Pozidriv no. 1 or with a 4 mm blade.

. For attaching: screwdriver with blade (5.5 mm max) or Pozidriv no. 1.

Positioning in a row:

. The product profile and positioning of the terminals allow single-phase and three-phase toothed connection supply busbars to be passed at the top of the product without impairing accessibility of the contactor terminals. This way it is possible to select the position of the pulse operated latching relay freely in the row and to connect the circuit breakers located on the same rail via a supply busbar.

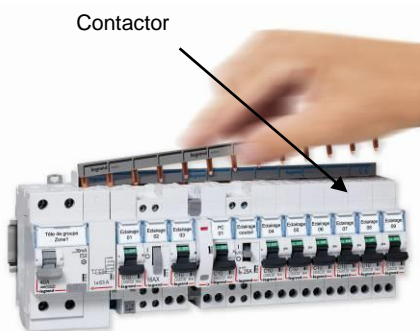

Examples of schematic diagrams:

. "2 NO" contactor

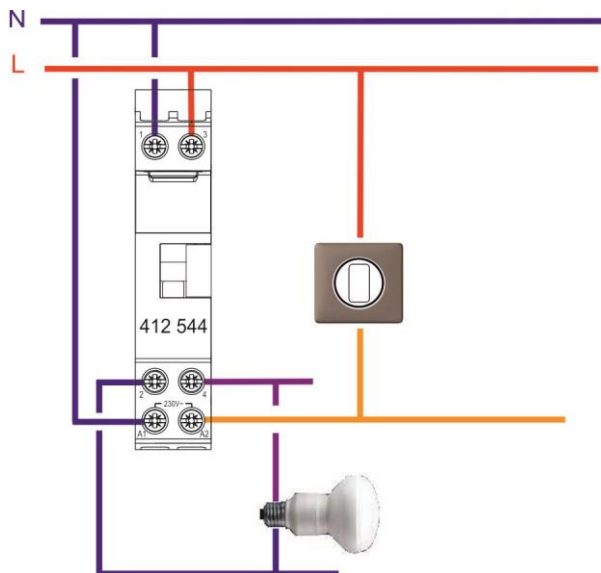

4. POSITIONING - CONNECTION (continued)

. "4NO used as a 3NO" contactor

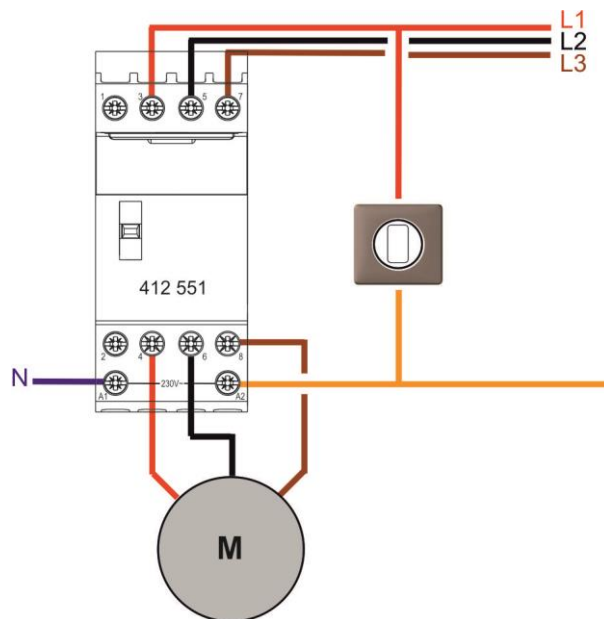

. "4 NO" contactor

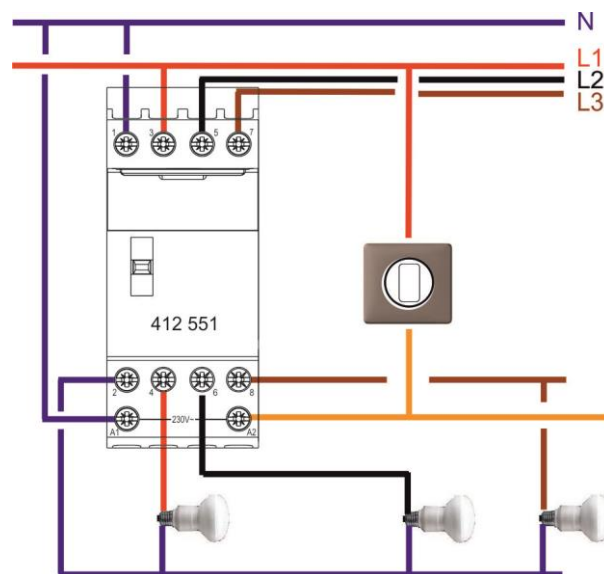

16 A and 25 A power contactors with or without handle

Catalogue number(s): 4 125 03 / 04 / 05 / 09 / 10 / 14 / 17 / 21 / 22 / 23 / 24 / 33 / 34 / 35 / 36 / 44 / 51 and 927 02 / 03

4. POSITIONING - CONNECTION *(continued)*

Connection:

- Screw control and power terminals:
 - Type of terminal: caged
 - Depth: 12 mm
 - Capacity (h x w): 4.7 x 4.7 mm
 - Compatible copper conductors
- Rigid or flexible without ferrule:
 - 1 x (0.75 to 4 mm² according to EN/IEC 61095, 6 mm² accepted) or 2 x (0.75 to 2.5 mm²)
- Flexible with single ferrule: 1 x (0.75 to 6 mm²)
- Flexible with double ferrule: 2 x (0.75 to 4 mm²)
 - Screw head: mixed head Pozidriv no. 1 and 4 mm blade
 - Screw head: mixed M3.5
 - Min. tightening torque: 0.5 Nm/max.: 1.2 Nm recommended: 0.8 Nm

Length of control lines:

- with 24 V contactor: 330 m for 1-module contactor or 100 m for 2-module contactor with 1.5 mm² cables
- with 230 V contactor: 250 m for 1-module contactor or 400 m for 2-module contactor regardless of the connection cable cross-section.

Degree of protection:

- Terminals protected against direct contact: IP2x (wired device)
- Front panel protected against direct contact: IP3XD
- Class II, front panel with faceplate
- Protection against impacts: IK04

Resistance to tremors:

- No change in the status of the contacts during the "resistance to tremors" test as defined by the standard EN 60898

Device handling:

- Via remote control (switch).
- Via ergonomic 3-position handle (I, auto, O) if the product is fitted with one.

Control status display:

- Via orange indicator showing the presence of the control signal or the forced switch-on status
- For contactors with a handle the position of the latter provides the following indications:
 - "I" position: Forced switch on/ON
 - "O" position: Forced switch off/OFF
 - "Auto" position: Automatic (the contact status depends on the electrical control)

Labelling:

- Marking of the circuits on the front panel with the label holder

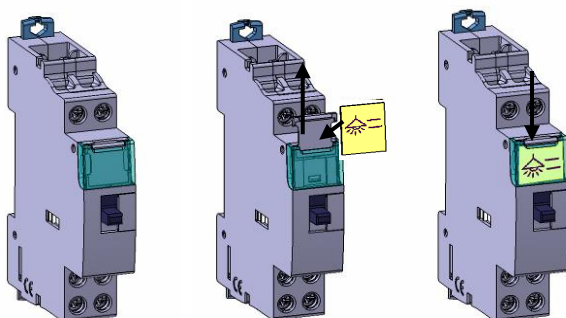

5. GENERAL CHARACTERISTICS

Marking:

- By indelible pad printing

- Front panel

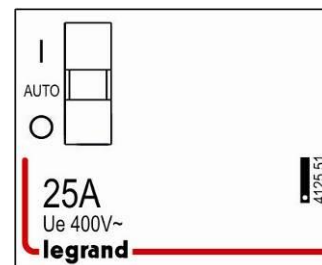
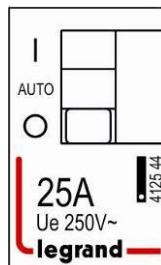

- Marking of the terminals:

Power: 1 to 8 Control: A1 and A2
Upper terminals

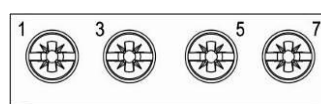
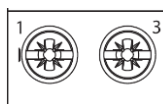

Lower terminals

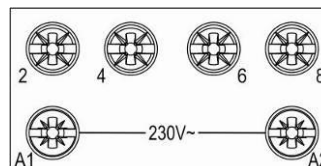
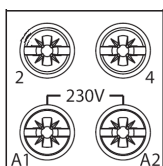

- By laser marking

- Upper panel

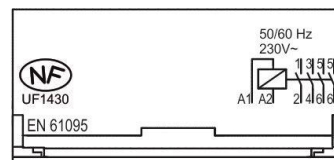
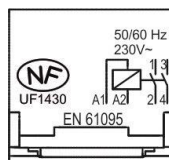

Isolation distance:

- Greater than 3 mm in accordance with standard EN 61095

Rated insulation voltage (Ui):

- 1-pole/ 2-pole/ 3-pole/ 4-pole: 440 V~

Degree of pollution:

- 2 in accordance with EN 61095

Insulation voltage between the control circuit and the power circuit:

- 4 kV

16A and 25A power contactors with or without handle

Catalogue number(s): 4 125 03 / 04 / 05 / 09 / 10 / 14 / 17 / 21 / 22 / 23 / 24 / 33 / 34 / 35 / 36 / 44 / 51 and 927 02 / 03

5. GENERAL CHARACTERISTICS (continued)

Rated impulse withstand voltage (Uimp):

. 4 kV

Resistance to electromagnetic disturbance (EMC):

. 1.2/50 μ s impulse resistance: category 4 (2 kV between lines, 4 kV between line and earth)

Impact of height:

. No impact up to 2,000 m

Rated frequency:

. 50/60 Hz

Rated operating current depending on the category of use (Ie):

. AC7a or AC1 (heating): Ie = 16 A or 25 A depending on the catalogue numbers

. AC7b or AC3 (motor control): Ie = 10 A (2.2 kW for 2NO and 4 kW for 4NO) for the 25 A contactors and Ie = 6.5 A for the 16 A contactors

Rated operating voltage (Ue):

. Ue = 250 V ~ for 1/2-pole

. Ue = 400 V ~ for 3/4-pole

Protection against short-circuits:

. Conditional short-circuit current Iq = 6 000 A in accordance with EN 61095

. Permissible thermal stress: 16 000 A²s

Recommendations:

. For protecting 16 A and 25 A contactors against short circuits depending on the conditional current Iq = 6 000 A NF EN 61095, using a circuit breaker or fuse gG with nominal voltage \leq 25 A is recommended.

Control voltage (Uc):

. Uc = 230 V~ or 24 V~

Control operating voltage:

. from 0.85 to 1.1 times Uc

Control return voltage:

. from 0.2 to 0.75 times Uc

Control pulse duration:

. 100 ms minimum

Rated service:

. Intermittent service: 600 operating cycles at the present time in accordance with EN 61095 (category 600)

Operating force using the handle:

. 1,000 g for closing and opening

Endurance:

In number of operating cycles (ON + OFF)

. Control via the handle: 500 operating cycles

. Electrical control:

- 1,000,000 operating cycles with no load
- 100,000 operating cycles at AC-7a in accordance with EN 61095 (same as at AC1)
- 150,000 operating cycles at AC-7b in accordance with EN 61095 (same as at AC3)

Operation at 400 Hz:

. no

5. GENERAL CHARACTERISTICS (continued)

DC usage:

. Control: does not work with DC

. Power circuit: NO contacts and NC contacts can be used to control loads supplied with DC in compliance with the derating table below

Ue	DC 1 (resistive load)			DC 3 (motors)		
	Number of poles in series			Number of poles in series		
	1 p	2 p	3 p	1 p	2 p	3 p
8 V=	25 A	25 A	25 A	21.5 A	25 A	25 A
12 V=	25 A	25 A	25 A	20 A	25 A	25 A
24 V=	25 A	25 A	25 A	16 A	25 A	25 A
48 V=	21 A	25 A	25 A	8 A	18 A	25 A
110 V=	7 A	16 A	25 A	1.6 A	6.5 A	16 A

Control consumption

Type of contact	Control voltage	Consumption in mA (at Un)	
		Holding	Inrush
2NO/NC+NO	24 V~	200	970
4NO		300	2500
2NO	230 V~	12	60
2NC		20	90
NC+NO		20	90
4NO		20	200

Type of contact	Control voltage	Consumption in W (at Un)	
		Holding	
2NO/NC+NO	24 V~	1.4	
4NO		2.1	
2NO	230 V~	0.8	
2NC		1.2	
NC+NO		1.2	
4NO		1.3	

AVERAGE dissipated power via contact at 230 V:

. 0.8 W via contact for 16 A contactor

. 1.8 W via contact for 25 A contactor

Annual consumption of the contactors:

. 230/400V 50Hz network power circuits

. Total consumption, control + power, in "standard" usage conditions.

Type of contact	Control voltage	Consumption in kWh (at Un)
NC+NO	24 V~	4
2NO		4.8
4NO		7.6
2NO	230 V~	3.1
2NC		1.0
NC+NO		3.4
4NO		5.4
4NC		2.0
2NC+2NO		4.4

16 A and 25 A power contactors with or without handle

Catalogue number(s): 4 125 03 / 04 / 05 / 09 / 10 / 14 / 17 / 21 / 22 / 23 / 24 / 33 / 34 / 35 / 36 / 44 / 51 and 927 02 / 03

5. GENERAL CHARACTERISTICS (continued)

Noise on holding:

. Traditional contactor: ≤ 45 dB at 1 cm

Operating temperature:

. A standard contactor is set to function with its nominal current at an ambient temperature of + 30°C

. In order to limit overheating the recommendation is to insert a spacing element (Cat. No. 406 307)

- every 2 contactors if the ambient temperature ≤ 40°C
- for every contactor if the ambient temperature is > 40°C

. The following derating needs to be applied depending on the ambient temperature values:

- from - 25°C to + 40°C, no derating
- from + 40°C to + 60°C with the derating below

Contactor rating	40°C	50°C	60°C
le = 16 A	16 A	14 A	13 A
le = 25 A	25 A	22 A	20 A

Storage temperature:

. From - 40°C to +70°C

Enclosure material:

. Polyamide

Plastic material characteristics:

. Compliance with the resistance to incandescent wire for 30 seconds in accordance with IEC 695-2-1:

- Handle: 650°C
- Other parts: 850°C

Weight:

. le = 16/25 A

Average 0.120 kg per 1-pole and 2-pole device
average 0.230 kg per 4-pole device

Packaged volume:

. 0.2 dm³ for the 1-pole and 2-pole devices packaged in units
. 1.6 dm³ for the 1-pole and 2-pole devices packaged in packs of 10
. 0.4 dm³ for the 4-pole devices packaged in units

Contactor selection chart:

For a 10-year service life with 200 days of usage per year

Heating

Maximum power depending on the number of operations per day (kW)						
Number of operations per day	≤ 50	75	100	250	500	
Single-phase heating	16 A	3.6	2.8	2.4	1.6	0.8
230 V~	25 A	5.6	4.4	3.7	2.5	1.25
Three-phase heating	25 A	16	13.7	11.3	5	3.7
400 V~	16 A	1.5				
Floor heating	25 A	2.3				

Motors (AC-7b)

Maximum power (kW)		
Single phase motor	16 A	1.5
230 V~	25 A	2.3
Three-phase motor	25 A	4
400 V~		

5. GENERAL CHARACTERISTICS (continued)

Lighting

Maximum number of bulbs per contact of the contactor in 230 V~ single-phase and 400 V~ three-phase + neutral networks
. In a 230 V~ three-phase network without neutral the values stated in these tables must be divided by $\sqrt{3}$

- Incandescent bulbs

Low-voltage tungsten 230 V~ and halogen filaments				
Unit power	40 W	60 W	75 W	100 W
16 A	45	30	24	19
25 A	60	48	38	30

Low-voltage tungsten 230 V~ and halogen filaments				
Unit power	150 W	200 W	500 W	1000 W
16 A	13	10	4	2
25 A	20	15	6	3

ELV halogen bulbs with ferromagnetic ballast						
Unit power	20 W	35 W	50 W	75 W	100 W	150 W
16 A	32	20	15	12	9	6
25 A	52	30	24	16	12	8

ELV halogen bulbs with electronic ballast						
Unit power	20 W	35 W	50 W	75 W	100 W	150 W
16 A	60	40	28	18	14	9
25 A	80	50	40	26	20	13

- Fluorescent tubes with ferromagnetic ballast

Single parallel compensated fluorescent tubes with ferromagnetic ballast					
Unit power	18 W	20 W	36 W	58 W	115 W
16 A	24	24	16	11	5
25 A	33	30	25	17	9

Double series compensated fluorescent tubes with ferromagnetic ballast					
Unit power	2 x 20 W	2 x 36 W	2 x 40 W	2 x 58 W	2 x 140 W
16 A	30	24	22	15	6
25 A	45	38	35	24	10

Quadruple series compensated fluorescent tubes with ferromagnetic ballast	
Unit power	4 x 18 W
16 A	16
25 A	24

Compact fluorescent tubes with integrated starter for ferromagnetic ballast				
Unit power	7 W	10 W	18 W	26 W
16 A	50	40	28	19
25 A	60	50	42	28

16 A and 25 A power contactors with or without handle

Catalogue number(s): 4 125 03 / 04 / 05 / 09 / 10 / 14 / 17 / 21 / 22 / 23 / 24 / 33 / 34 / 35 / 36 / 44 / 51 and 927 02 / 03

5. GENERAL CHARACTERISTICS (continued)

- Fluorescent tubes with electronic ballast

Single fluorescent tubes electronic ballast				
Unit power	18 W	30 W	36 W	58 W
16 A	72	42	36	22
25 A	110	68	58	36

Double fluorescent tubes with electronic ballast			
Unit power	2 x 18 W	2 x 36 W	2 x 58 W
16 A	36	20	12
25 A	56	30	19

Triple fluorescent tubes with electronic ballast (series compensated)		
Unit power	3 x 14 W	3 x 18 W
16 A	34	26
25 A	46	38

Quadruple fluorescent tubes with electronic ballast (series compensated)		
Unit power	4 x 14 W	4 x 18 W
16 A	26	20
25 A	37	28

Compact fluorescent tubes with built-in electronic power supply					
Unit power	7 W	11 W	15 W	20 W	23 W
16 A	120	80	64	50	43
25 A	200	125	90	70	60

- Discharge lamps with compensation

Metal halogenide						
Unit power	35 W	70 W	100 W	150 W	250 W	400 W
16 A	10	6	5	3	2	1
25 A	15	9	7	5	3	2

Low pressure sodium vapour						
Unit power	18 W	35 W	55 W	90 W	135 W	180 W
16 A	12	6	5	3	2	2
25 A	20	10	7	5	3	3

High pressure sodium vapour					
Unit power	70 W	150 W	250 W	400 W	1000 W
16 A	8	7	5	3	1
25 A	10	9	6	4	2

High pressure mercury vapour					
Unit power	50 W	80 W	125 W	250 W	400 W
16 A	11	8	6	3	2
25 A	15	10	8	4	3

High pressure mixed				
Unit power	100 W	160 W	250 W	400 W
16 A	9	6	4	2
25 A	11	7	5	3

ELV halogen bulbs with electronic ballast						
Unit power	20 W	35 W	50 W	75 W	100 W	150 W
16 A	60	40	28	18	14	9
25 A	80	50	40	26	20	13

5. GENERAL CHARACTERISTICS (continued)

- Led lamps

Led lamps number without driver or not dimmable										
In (A)	2W	5W	7W	9W	12 W	18 W	22 W	30 W	40 W	50 W
16 A	16	16	16	16	16	15	14	12	10	9
25 A	30	30	30	30	30	27	25	22	18	15

Led lamps number with driver or dimmable										
In (A)	2W	5W	7W	9W	12 W	18 W	22 W	30 W	40 W	50 W
16 A	40	40	40	35	35	33	30	27	23	20
25 A	65	65	65	60	60	56	51	45	33	30

6. EQUIPMENT AND ACCESSORIES

Auxiliaries:

- NO+NC changeover contact signalling auxiliaries catalogue numbers: 4 124 29 and 4 124 30.
- Catalogue number 4 124 29 for 1 module wide 2-pole contactors
- Catalogue number 4 124 30 for 2 module wide 3 and 4-pole contactors
- Installed to the left of the contactor
- For signalling the position status of the contacts of the product to which it is attached
- maximum of 2 auxiliaries per contactor

Attaching auxiliaries:

- Auxiliaries are installed to the left of the contactors

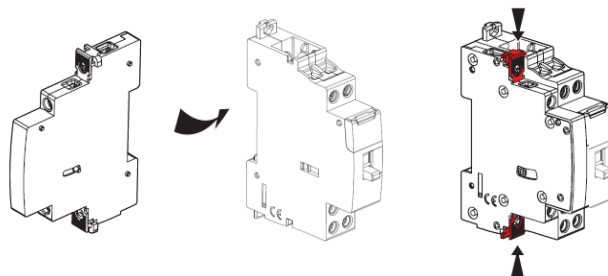

16 A and 25 A power contactors with or without handle

Catalogue number(s): 4 125 03 / 04 / 05 / 09 / 10 / 14 / 17 / 21 / 22 / 23 / 24 / 33 / 34 / 35 / 36 / 44 / 51 and 927 02 / 03

6. EQUIPMENT AND ACCESSORIES *(continued)*

Attaching auxiliaries *(continued)*:

- . Option of adding two signalling auxiliaries per contactor
- Cat. No. 4 124 29

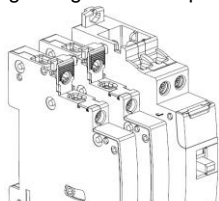

- Cat. No. 4 124 30

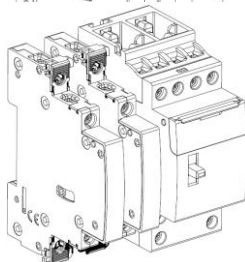

7. COMPLIANCE AND APPROVALS

Compliance with standards:

- . NF EN 61095/IEC 61095
- . NF EN 60947-4-1: AC1 and AC3

Classification in accordance with Appendix Q: (standard IEC/EN 60947-1)

- . Category F

Inter alia: temperature test range -25°C/+70°C, vibration test 2 Hz to 13.2 Hz with ± 1 mm movement, 13.2 Hz to 100 Hz acceleration ± 0.7 g, salt spray in accordance with IEC 60068-2-52

Respect for the environment – Compliance with European Union Directives:

- . Compliance with Directive 2002/95/EC of 27/01/03 known as "RoHS" which provides for a restriction on the use of dangerous substances such as lead, mercury, cadmium, hexavalent chromium and polybrominated biphenyl (PBB) and polybrominated diphenyl ether (PBDE) brominated flame retardants from 1st July 2006
- . Compliance with the Directive 91/338/EEC of 18/06/91 and decree 94-647 of 27/07/04

Plastic materials:

- . Plastic material without halogen.
- . Labelling of parts compliant with ISO 11469 and ISO 1043.

Packaging:

- . Design and manufacture of packaging compliant with decree 98-638 of 20/07/98 and Directive 94/62/EC

Approvals obtained:

- . France: NF