

WORKSHOP SPECIFICATIONS

XL³ 125

MODULAR CABINETS



With their optimised dimensions and modularity, XL³ 125 enclosures allow a distribution up to 125 A, thanks to a capacity of 18 modules per row, covering from 1 to 4 rows.

They also offer the possibility of adding an electrical box and comply with the regulations in public access building (ERP) and High-rise buildings (IGH) to meet a residential or tertiary application.

Available accessories such as the joining kit and the Mosaic device mounting accessory allow the cabinet to be adapted to the needs of the building.

LEGAL INFORMATION

Presentation pictures do not always include Personal Protective Equipment (PPE), but this is a legal and regulatory obligation that must be scrupulously respected.

In accordance with its continuous improvement policy, Legrand reserves the right to change the specifications and illustrations without notice. All illustrations, descriptions and technical information included in this document are provided as indications and cannot be held against Legrand.

TABLE OF CONTENTS

Safety instructions.....	2
XL ³ 125 cabinets	4
Specifications	4
Choice of products	4
Schematic view of an XL ³ 125 cabinet	5
Dimensions (countries).....	5
Presentation of the cabinets.....	6
Capacity of terminal blocks supplied with the cabinets.....	6
Accessories supplied with the cabinet	6
Cabinet accessories.....	7
Using the cabinet.....	9
Mounting modular products and moulded cases	11
Electrical box accessories (for France only)	11
Distribution systems.....	12
Installation and fixing	13

SAFETY

INSTRUCTIONS

General information

- Use only the products and accessories recommended by the Legrand Group in the catalogue, instructions, technical data sheets and all other documents provided by Legrand (hereinafter referred to as «the Documentation») in compliance with the installation rules.
- Improper installation and/or use may result in the risk of arcing in the enclosure, overheating or fire. The enclosures must be used under normal conditions, they must not be subjected to Voltage / Current / Temperature values other than those specified in the Documentation.
- Legrand declines all responsibility for any modification or repair of the equipment making up the enclosure that is not authorized by the Legrand Group, as well as any failure to comply with the rules and recommendations specified by Legrand in the Documentation. In addition, in the cases mentioned above, the warranty granted by Legrand will not be applicable.
- It is necessary to check that the characteristics of the products are appropriate for their environment and use during maintenance operations, and to refer to the Documentation. If you have any questions or require clarification, please contact Legrand Group.
- The installation, use and maintenance of the enclosures and their components must be carried out by qualified, trained and authorized personnel, in accordance with the regulations in force in each country.



RISK OF ELECTRIC SHOCK, BURNS AND EXPLOSION.

- People working on the installation must have the appropriate electrical authorizations for the work to be carried out.
- Wear the PPE (Personal Protective Equipment) necessary to work on live products.
- Respect the safety rules related to electrical work.
- Improper electrical and mechanical use of equipment can be dangerous and may result in personal injury or damage to property.
- Depending on the maintenance operations to be carried out, partial or total power cuts of the enclosure concerned should be planned before any work.
- When performing operations that involve access to the inside of the enclosure, be aware of the risk of burns before touching any products or metal parts.
- Before turning the power back on, make sure that there are no foreign bodies and that all physical protections have been put back in place (e.g.: screens, covers, shields).

Any failure to strictly apply the procedures and to respect these recommendations, could lead to serious risk of accident, endangering people and property (in particular, without limitation, risk of burns, electric shocks, etc.).



 The rules and recommendations in this document are based on our knowledge of the typical conditions of use of our products in the fields of application usually encountered. However, it is always the customer's responsibility to verify and validate that Legrand products are suitable for its installation and use.

The customer must ensure proper installation, maintenance and operation of the equipment to avoid any risk of injury to personnel or damage to property in the event of product failure, especially for applications that require a very high level of safety (e.g., those in which the failure of a component may endanger human life or health).

The rules for storage, handling, installation and maintenance and the appropriate precautions and warnings must be strictly observed and applied.

XL³ 125 CABINETS

XL³ 125 cabinets are modular surfacemounting cabinets, with 1 to 4 rows of 18 modules, which can accommodate a distribution block up to 125 A.

Thanks to the tilting removable chassis and rails which can be taken out without tools, XL³ 125 cabinets offer unobstructed access when connecting cables.

SPECIFICATIONS

- Class II insulated cabinet
- Cabinet without door: IP 30-IK 08
- Cabinet with optional door: IP 40-IK 09
- Self-extinguishing: 650°C (cabinets supplied without terminal blocks) 750°C (cabinets supplied with terminal blocks)
- Conforming to current standards EN 60439-3, EN 60670-24, EN 62208
- Colour of box and cover: white RAL 9003
- Rated operating and insulation voltage: 400 VA 50/60 Hz
- Short-circuit current: 10 kA
- Maximum permissible current:
 - Cat.no 4 016 11/52/53/76 = 63 A
 - Cat.no 4 016 12/77 = 90 A
 - Cat.no 4 016 13/14/78/79 = 125 A

CHOICE OF PRODUCTS

the XL³ 125 range consists of “fully modular” cabinets with 1 to 4 rows of 18 modules as well as electrical boxes (for France only) which can take a main circuit-breaker on its own, or a circuit-breaker and a single-phase electrical energy meter.



XL³ 125 CABINETS



XL³ 125 ELECTRICAL BOX

	Number of rows	Number of modules	Cabinet Cat.no	
			FRANCE (Supplied with terminal blocks)	EXPORT (Supplied without terminal blocks)
«Modular» cabinets	1	18	4 016 11	4 016 76
	2	36 (2 x 18)	4 016 12	4 016 77
	3	54 (3 x 18)	4 016 13	4 016 78
	4	72 (4 x 18)	4 016 14	4 016 79
Electrical boxes	1	Incoming circuit-breaker only	4 016 52	-
	1	Incoming circuit-breaker + energy meter	4 016 53	-

SCHEMATIC VIEW OF AN XL³ 125 CABINET

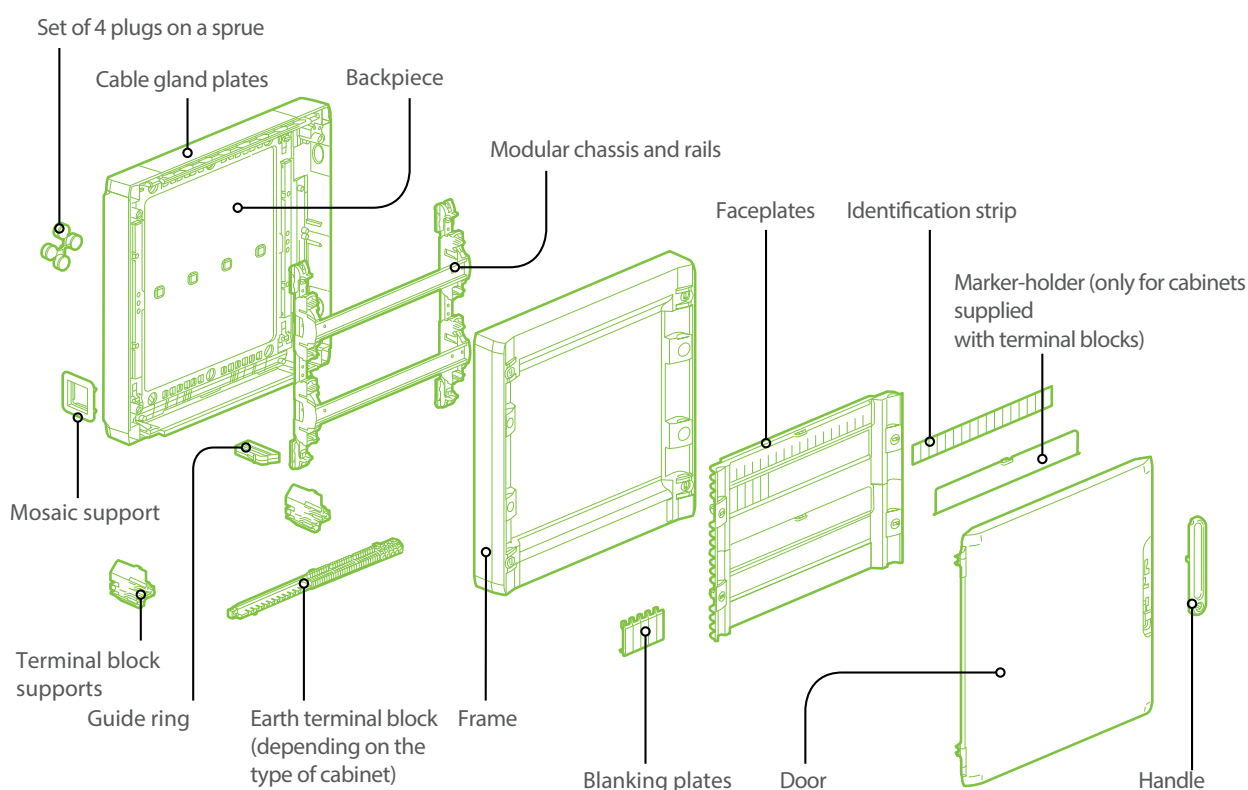

DIMENSIONS

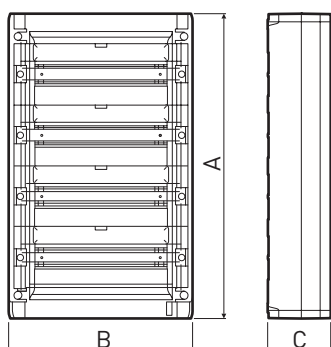

Cat.no		A (mm)	B (mm)	C (mm)	
France	Export			Without door	With door
4 016 11	4 016 76	300	450	128	150
4 016 12	4 016 77	450	450	128	150
4 016 13	4 016 78	600	450	128	150
4 016 14	4 016 79	750	450	128	150
4 016 52/53		300	450	128	150

XL³ 125 CABINETS

PRESENTATION OF THE CABINETS



XL³ 125 cabinets are supplied assembled and packed in individual boxes. these can be re-used for onward shipping.



We recommend using a 6.5 mm flat screwdriver to open and close the XL³ 125 cabinets, and also for positioning the faceplates with a ¼ turn, for which 1 nm tightening torque is sufficient.

CAPACITY OF TERMINAL BLOCKS SUPPLIED WITH THE CABINETS

Cat.nos	AUTOMATIC CONNECTION EARTH TERMINAL BLOCK			IP 2X TERMINAL BLOCKS	
	Automatic terminals 1,5 to 4 mm ²	Screw terminals		Earth (green)	Neutral (Blue)
		6 to 25 mm ²	6 to 35 mm ²		
France	4 016 11	18 (2 x 9)	5	-	-
	4 016 12	27 (3 x 9)	5	-	-
	4 016 13	36 (4 x 9)	5	-	-
	4 016 14	45 (5 x 9)	5	5	-
Export	4 016 76	-	-	-	-
	4 016 77	-	-	-	-
	4 016 78	-	-	-	-
	4 016 79	-	-	-	-

ACCESSORIES SUPPLIED WITH THE CABINETS

Cat.nos	5 MODULE BLANKING PLATES	MOSAIC GRID	GUIDE RINGS	SET OF 4 PLUGS ON A SPRUE	18 MODULE ID-STRIPS	
France	4 016 11	1	1	-	2	1
	4 016 12	2	1	2	2	2
	4 016 13	3	1	3	2	3
	4 016 14	3	1	4	2	4
	4 016 52	3	-	-	2	1
	4 016 53	1	-	-	2	1
Export	4 016 76	1	-	-	2	1
	4 016 77	2	-	-	2	2
	4 016 78	3	-	-	2	3
	4 016 79	3	-	-	2	4

CABINET ACCESSORIES

■ Joining kit – Cat.no 4 018 45

The joining kit is used to join two XL³ 125 cabinets horizontally or vertically.



Two cabinets of the same height or width can be joined together, and also cabinets of different heights. electrical boxes can be joined vertically, or horizontally on a taller cabinet.

■ Doors –

Cat.no 4 018 61/62/63/64/71/72/73/74

The doors are reversible and come in transparent plastic or opaque white (RAL 9003).

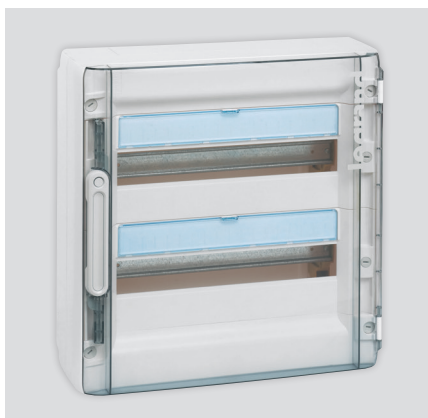

A snap connection system means the door is easily fitted without needing to hold it. For maximum safety, the grey handle (ral 7035) with two locking points can be fitted with a key-operated lock Cat.no 4 018 51.

■ Key operated lock – Cat.no 4 018 51

The key-operated lock is fitted on the door handles of the XL³ 125 cabinets. The keys are eurolocks no. 850.



■ Fixing lugs – Cat.no 4 018 56

This catalogue number comprises four lugs for fixing XL³ 125 cabinets from the outside. the lugs are fixed at the back of the cabinets and can be positioned vertically or horizontally. The various fixing centres are specified on pages 13 and 14.



■ **Document holder - Cat.no 4 018 44**

This self-adhesive document holder can hold electrical diagrams, instructions, etc for the cabinet. It is attached to the cabinet low down on the front, and does not obstruct use of a door. Its repositioning system allows the document holder to be removed in order to open the faceplate, without touching the frame of the cabinet.



■ **Blanking plate - Cat.no 0 016 60**

In addition to those already supplied in the cabinets, blanking plates can be used to close the modular windows in the XL³ 125 cabinet faceplates. Each 5-module strip of blanking plates, white RAL 9003, can be separated into half-modules.

It is also possible to use separable blanking plates Cat.no 0 016 62 and 0 016 64 of 13 and 18 modules respectively, white RAL 9010.



■ **Solid faceplate - Cat.no 4 018 55**

The solid faceplate is fitted in place of a modular faceplate. It is used to integrate non-modular products (OSMOZ control and signalling auxiliary, etc). The faceplate useful area is 318 x 144 mm.



■ **Perforated plate - Cat.no 4 018 53**

The perforated plate is fixed in place of a modular rail, on the metal uprights of XL³ 125 cabinets with 2 or more rows, using the four screws supplied. Its useful area is 342 x 144 mm, and when the plate is fixed under a solid faceplate, the space is 85 mm.

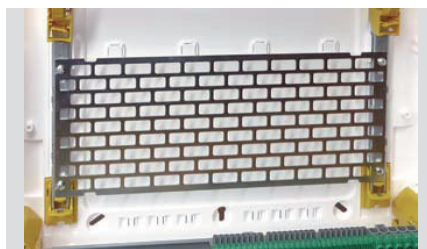

■ **Double terminal block support - Cat.no 4 018 57**

This terminal block support is in addition to the one already supplied with XL³ 125 cabinets. It allows terminal blocks to be added with the empty support Cat.no 4 048 21.

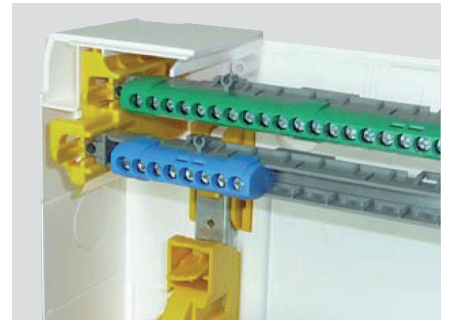

The support can be removed simply by pressing its base on the inside, without any tools.

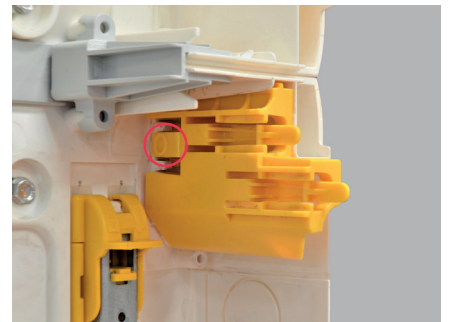

■ **Mosaic support – Cat.no 4 018 50**

This accessory is used for fixing a 2-module mechanism from the Mosaic range on one side of the XL³ 125 cabinet.

The cabinets have 2 slots at the top and bottom of each side panel.



USING THE CABINET

REMOVABLE CHASSIS AND RAIL

On-site, in one easy action and without tools, thanks to the following 3 features:

■ **Removable chassis**

By unlocking all 4 corners of the chassis, the whole chassis can be removed from the XL³ 125 cabinet. You can therefore install your equipment on a work surface or fix the back of the cabinet without risking damaging the installed equipment.

■ **Pivoting chassis**

The chassis can be tilted by unlocking just the bottom or top corners. This makes it easy to run cables through without the various rails and installed devices getting in the way.



■ **Removable rail**

The rails of XL³ 125 cabinets can be removed from the chassis individually. The rail supports have clips so there is no need to use tools. This makes it easier to access the cables running behind the rails.



CABLE ENTRY PLATE

XL³ 125 cabinets have two cable entry plates, one at the top and one at the bottom, which can be removed and refitted manually without the need for tools. Each plate has a large number of cut-outs for adapting to the different sizes of housing service duct. cut-outs can be made in the plates using wire cutters.



XL³ 125 CABINETS

CABLE RUNS

XL³ 125 cabinets have two removable cable entry plates, one at the top and one at the bottom. In line with these plates, the back of XL³ 125 cabinets has attachment points for securing cables or sleeves using Colson cable ties.



There are also attachment points between the rails for securing the wiring, horizontally or vertically.



First, open up the hole using a flat screwdriver



The cables or sleeves are then secured using Colring and Colson cable ties (up to 9 mm wide).



Tilting the chassis makes it easier to run cables behind the equipment. this can be done without tools and in either direction.



The chassis can be pulled out completely to make it easier to fix the cabinet in place, or to install and wire up equipment on a work surface.

Cables can also be run down the side of the chassis using the guide rings supplied with the cabinets or with LINA 25 cable ducting.



XL³ 125 cabinets can accommodate LINA 25 cable ducting with maximum dimensions of 40 x 60 mm [Cat.no 0 362 07]

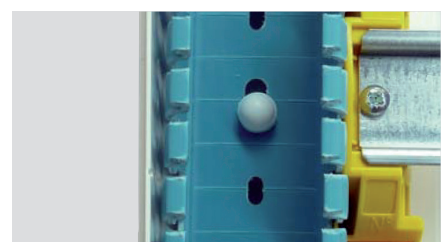

MOUNTING MODULAR PRODUCTS AND MOULDED CASES

With a space of 150 mm between the rail fixing centres, any modular product can be installed

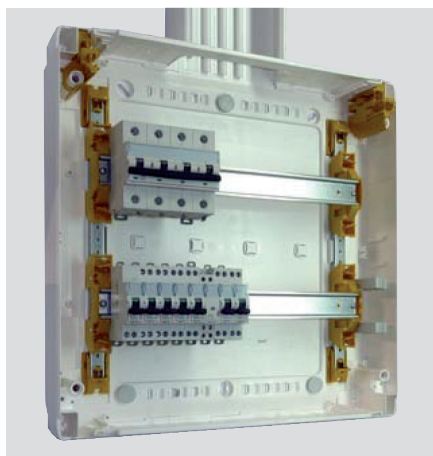

The 2 position rail allows a DPX³ MCCB to be integrated in XL³ 125 cabinets.

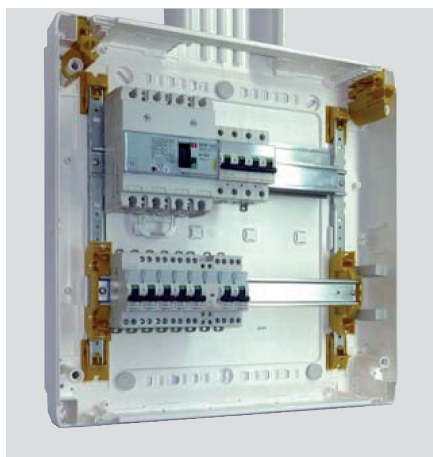

With the height spacer Cat.no 0 262 99, DPX³ 125 moulded case products and modular products can be installed on the same rail.

ELECTRICAL BOX ACCESSORIES (FOR FRANCE ONLY)

Electrical boxes take plates for main circuit-breakers used on the French market (eg: baco incoming circuit-breaker). they can be added to XL³ 125 cabinets vertically or horizontally and are reversible.



Electrical box Cat.no 4 016 52 is used to connect a subscriber MCB. This cabinet is supplied with plate Cat.no 4 011 91, on which the 2-pole or 4-pole "blue tariff" circuit-breaker is fixed (government-regulated French electricity tariff).



Electrical box Cat.no 4 016 53 is used to connect a subscriber MCB and a CBE or LINKY single-phase electronic meter. This cabinet is supplied with plate Cat. no 4 011 81, on which the "blue tariff" circuit-breaker is fixed.



Up to 4 modules can be added to this electrical box, on the modular rail.

DISTRIBUTION SYSTEM

All standard optimised distribution systems with a cabinet size up to 125 a can be fitted in XL³ 125 cabinets.

■ IP 2X insulated terminal blocks

IP 2X insulated terminal blocks can be fixed directly on the rails of the XL³ 125 cabinet, or on a 12 x 2 bar.

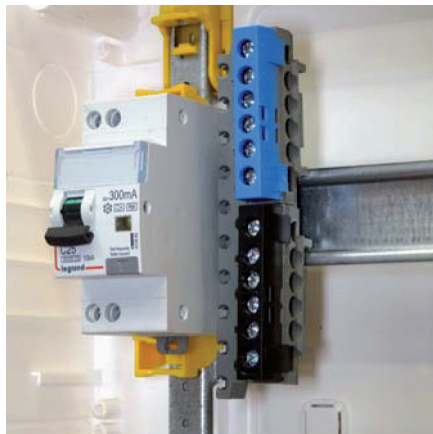

■ Modular distribution blocks

Modular distribution blocks: single-pole, 2-pole or 4-pole; with a voltage up to 500 V; 40 a to 125 a can easily be used in XL³ 125 cabinets.



■ Optimised HX³ single-phase horizontal supply busbar up to 63 A

Thanks to the automatic double terminals on the DNX³ and DX³ uni + neutral circuit breakers, using universal supply busbar and accessories, connection is easily made in a single movement, regardless of the row organization: circuit breakers, auxiliaries and control devices follow each other in the order of the electrical diagram. The connection is totally reliable, guaranteed over time.



■ Optimised HX³ 4-pole horizontal supply busbar up to 63 A

The four-pole «group head» supply busbar, the double automatic terminals on the DX³ circuit-breakers, as well as the various adapted accessories, allow connection in a single movement, whatever the arrangement of the row: all-polarity circuit-breakers, auxiliaries and control devices follow one another in the order of the electrical diagram. The connection is totally reliable, guaranteed over time.

■ Conventional HX³ prong type supply busbar up to 63 A

Conventional HX³ busbars supply power to a row or a group of modular devices with screw terminals. Only devices with 1 pole per module and without an add-on module can be connected to these busbars

■ VX³ vertical supply busbar phase + neutral up to 63 A

Single-phase 4-pole vertical supply busbars with 150 mm fixing centres are ideal for installation in XL³ 125 cabinets. their optimised dimensions free up space for fast, reliable connection from one row to the next.

■ VX³ 4-pole vertical supply busbar up to 63 A

The 4-pole supply busbar is equipped with automatic output terminals. Distribution is possible via flexible wires, with or without ferrules. This busbar can be supplied with power via the top or bottom screw terminals. Their dimensions and fixing system free up the maximum amount of space on the modular rails or at the back of the cabinet.

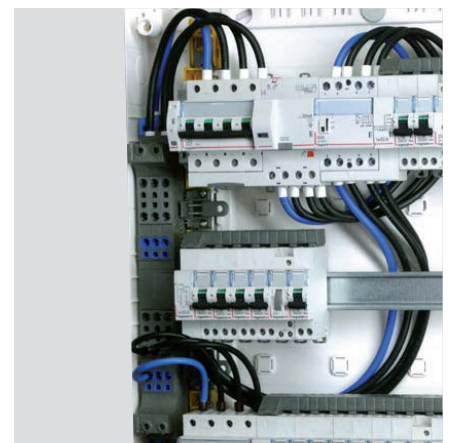

 Do not work on the 4-pole vertical supply busbar when it is live.

INSTALLATION AND FIXING

All XL³ 125 cabinets have 2 fixing methods via the inside of the cabinet:

- Fixing from a central point: this hanging method is used to obtain a vertical cabinet thanks to a single central point at the top and 2 points at the bottom.

- Fixing with 4 adjustable points For each fixing point, the maximum screw diameter is 6 mm.

All cabinets are supplied with two sets of 4 plugs on a sprue. Once the cabinet has been fixed to the wall, fitting these plugs maintains the cabinet IP and class II protection.

■ Cabinets only

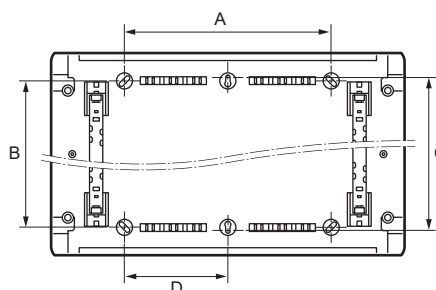

XL ³ 125 (France)		A	B	C	D
1 row	4 016 11	260	250	250	130
2 rows	4 016 12	260	365	365	130
3 rows	4 016 13	260	515	515	130
4 rows	4 016 14	260	665	665	130
Consumer unit	4 016 52	260	250	250	130
	4 016 53	260	250	250	130

■ Cabinets only with fixing lugs

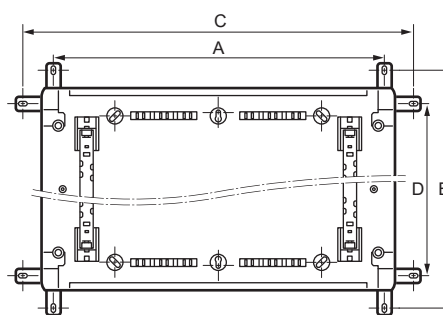

XL ³ 125 (France)		A	B	C	D
1 row	4 016 11	406	355	505	213
2 rows	4 016 12	406	505	505	363
3 rows	4 016 13	406	655	505	513
4 rows	4 016 14	406	805	505	663
Consumer unit	4 016 52	406	355	505	213
	4 016 53	406	355	505	213

XL³ 125 CABINETS

■ Joined cabinets

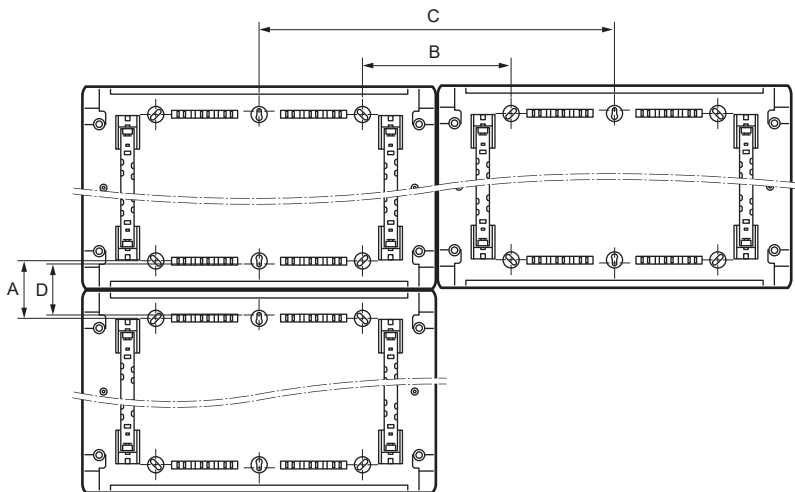

XL ³ 125		A	B	C	D
France	Export	50	190	450	38

■ Joined cabinets with fixing lugs

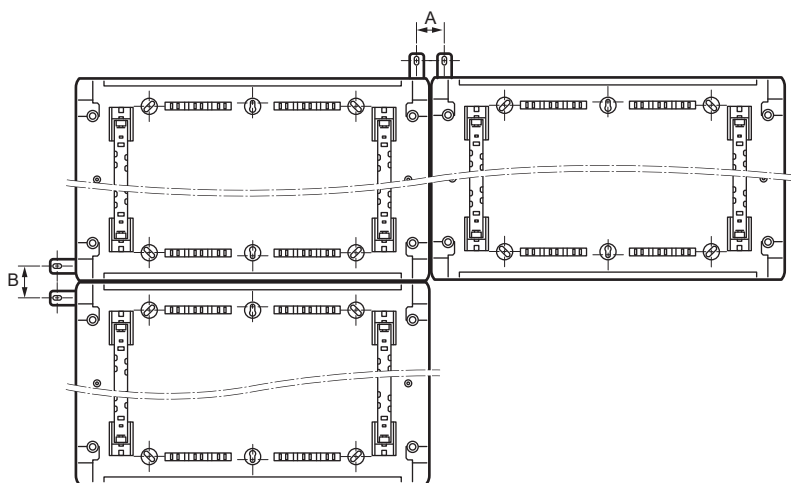

XL ³ 125		A	B
France	Export	44	87

To know more,
check export.legrand.com



All technical data of the products inside this workshop specifications book are available on: www.export.legrand.com/en

Click on **>DOCUMENTATION & SOFTWARE**

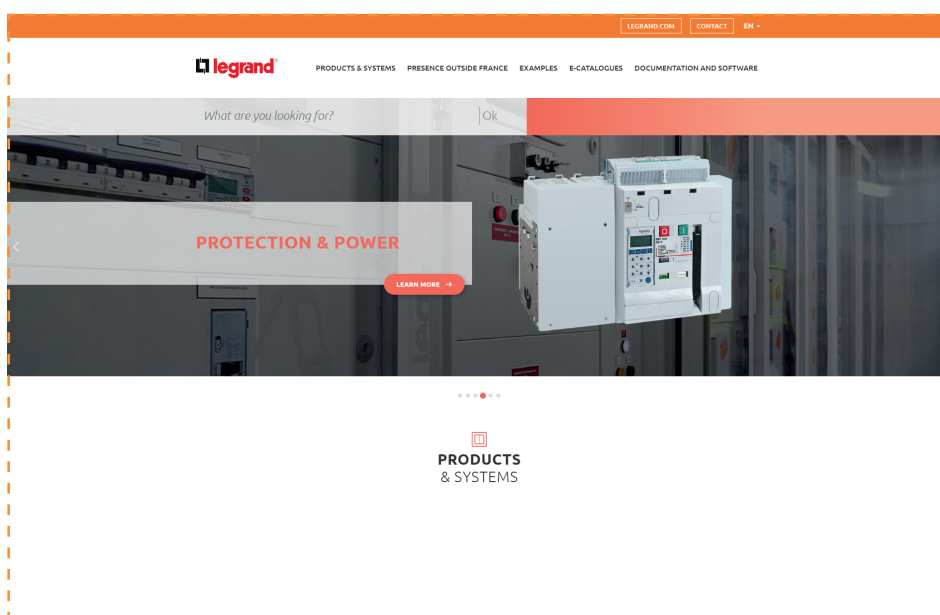



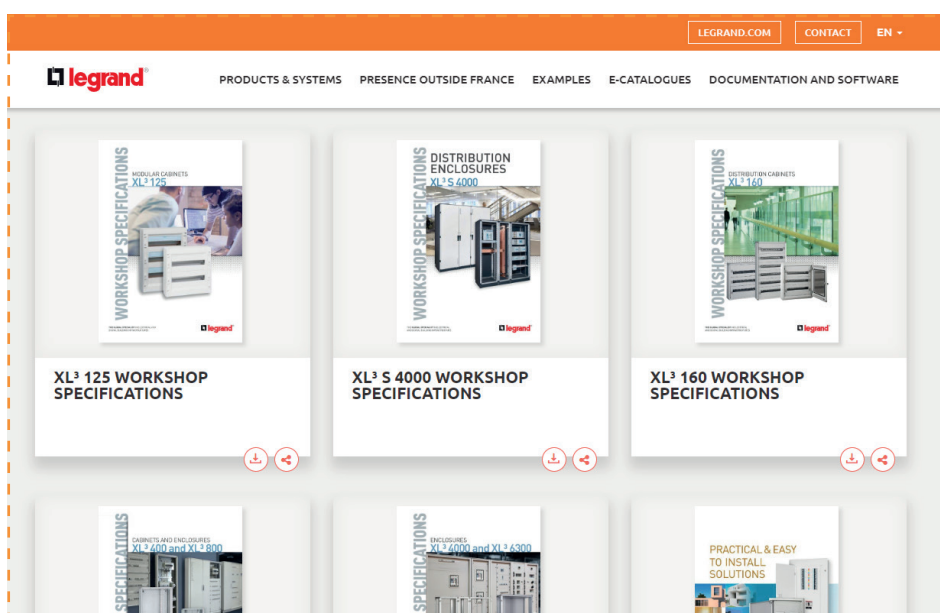

>DOCUMENTATION





FOLLOW US
ALSO ON

- @ legrand.com
-  youtube.com/user/legrand
-  facebook.com/Legrand
-  twitter.com/Legrand
-  pinterest.com/legrandgroup
-  instagram.com/legrandnews



Head office
and International Department
87045 Limoges Cedex - France
Tel: + 33 (0) 5 55 06 87 87
Fax: + 33 (0) 5 55 06 74 55