



■ Features

- Universal AC input / Full range
- Protections: Short circuit / Overload / Over voltage
- Battery low protection / Battery polarity protection by fuse
- Can be installed on DIN rail TS-35/7.5 or 15
- Alarm signal for AC OK and Battery low
- Cooling by free air convection
- LED indicator for power on
- 100% full load burn-in test
- 3 years warranty

■ Applications

- Security system
- Emergency lighting system
- Alarm system
- UPS system
- Central monitoring system
- Access systems

■ Description

DRC-60 series is a 60W AC/DC DIN Rail type security power supply, allowing a universal input range between 90VAC and 264VAC . In addition to the primary output, there is a charger output, with the smaller rated current, that provides the backup power supply application the security access systems require. With the efficiency DRC-60 is up to 88% ; it can operate with air convection under -30°C through 70°C. This series is designed with thorough alarm features, including AC OK and battery low signaling; moreover, the relay contact is provided to facilitate users' system designs.

■ Model Encoding

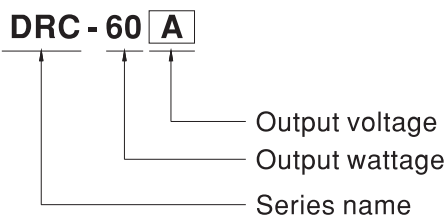



SPECIFICATION

MODEL		DRC-60A		DRC-60B	
OUTPUT	OUTPUT NUMBER	CH1	CH2	CH1	CH2
	DC VOLTAGE	13.8V	13.8V	27.6V	27.6V
	RATED CURRENT	2.8A	1.5A	1.4A	0.75A
	CURRENT RANGE	0 ~ 4.3A	-----	0 ~ 2.15A	-----
	RATED POWER	59.34W		59.34W	
	RIPPLE & NOISE (max.) Note.2	120mVp-p		200mVp-p	
	VOLTAGE ADJ. RANGE	CH1: 12 ~ 15V		CH1: 24 ~ 30V	
	VOLTAGE TOLERANCE Note.3	± 1.0%	-----	± 1.0%	-----
	LINE REGULATION	± 0.5%	-----	± 0.5%	-----
	LOAD REGULATION	± 0.5%	-----	± 0.5%	-----
	SETUP, RISE TIME Note.4	400ms, 50ms/230VAC		800ms, 50ms/115VAC at full load	
HOLD UP TIME (Typ.)	50ms/230VAC		10ms/115VAC at full load		
INPUT	VOLTAGE RANGE	90 ~ 264VAC 127 ~ 370VDC [DC input operation possible by connecting AC/L(+), AC/N(-)]			
	FREQUENCY RANGE	47 ~ 63Hz			
	EFFICIENCY (Typ.)	86%		88%	
	AC CURRENT (Typ.)	1.3A/115VAC 0.8A/230VAC			
	INRUSH CURRENT (Typ.)	COLD START 30A/115VAC		60A/230VAC	
PROTECTION	OVERLOAD	105 ~ 150% rated output power Protection type : Hiccup mode, recovers automatically after fault condition is removed			
	OVER VOLTAGE	CH1:14.49 ~ 18.63V		CH1:28.98 ~ 37.26V	
	BATTERY CUT OFF	10.5±0.5V		21±1V	
FUNCTION	AC OK	Relay contact output, ON : AC OK ; OFF : AC Fail ; max. rating : 30V/1A			
	BATTERY LOW	Relay contact output, OFF : Battery OK ; ON : Battery Low ; max. rating : 30V/1A		Battery low voltage : < 22V	
ENVIRONMENT	WORKING TEMP.	-30 ~ +70°C (Refer to "Derating Curve")			
	WORKING HUMIDITY	20 ~ 90% RH non-condensing			
	STORAGE TEMP., HUMIDITY	-40 ~ +85°C, 10 ~ 95% RH			
	TEMP. COEFFICIENT	±0.03%/°C (0~50°C) on CH1 output			
	VIBRATION	10 ~ 500Hz, 2G 10min./1cycle, 60min. each along X, Y, Z axes			
SAFETY & EMC (Note 5)	SAFETY STANDARDS	UL60950-1, TUV EN60950-1 approved			
	WITHSTAND VOLTAGE	I/P-O/P:3KVAC I/P-FG:2KVAC O/P-FG:0.5KVAC			
	ISOLATION RESISTANCE	I/P-O/P, I/P-FG, O/P-FG:100M Ohms / 500VDC / 25°C / 70% RH			
	EMC EMISSION	Compliance to EN55022 (CISPR22) Class B, EN61000-3-2,-3			
OTHERS	EMC IMMUNITY	Compliance to EN61000-4-2,3,4,5,6,8,11, EN55024, EN61204-3, light industry level, criteria A			
	MTBF	422.8K hrs min. MIL-HDBK-217F (25°C)			
	DIMENSION	40*90*100mm (W*H*D)			
NOTE	PACKING	0.3Kg; 42pcs/13.6Kg/0.82CUFT			
		1. All parameters NOT specially mentioned are measured at 230VAC input, rated load and 25°C of ambient temperature. 2. Ripple & noise are measured at 20MHz of bandwidth by using a 12" twisted pair-wire terminated with a 0.1uf & 47uf parallel capacitor. 3. Tolerance : includes set up tolerance, line regulation and load regulation. 4. Length of set up time is measured at cold first start. Turning ON/OFF the power supply may lead to increase of the set up time. 5. The power supply is considered a component which will be installed into a final equipment. The final equipment must be re-confirmed that it still meets EMC directives.			

■ **Block Diagram**

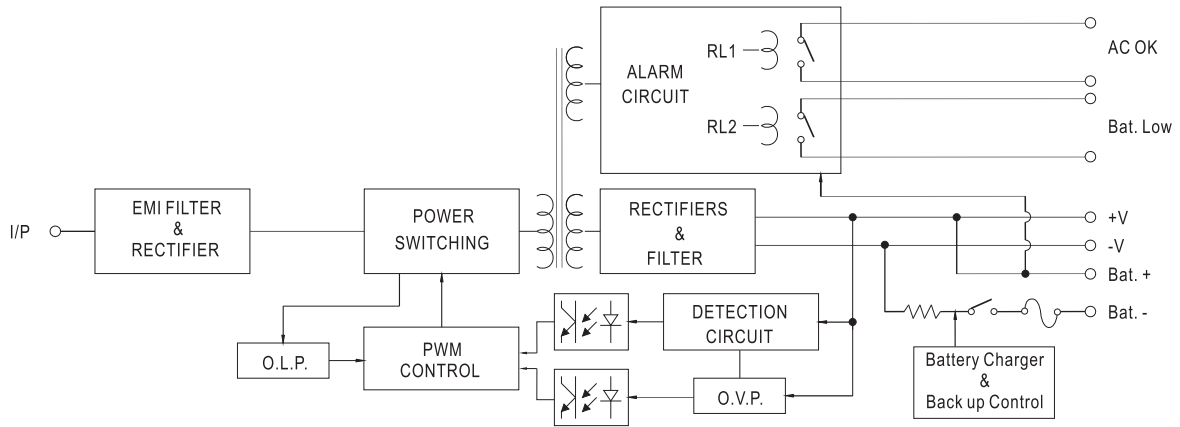

■ **Derating Curve**

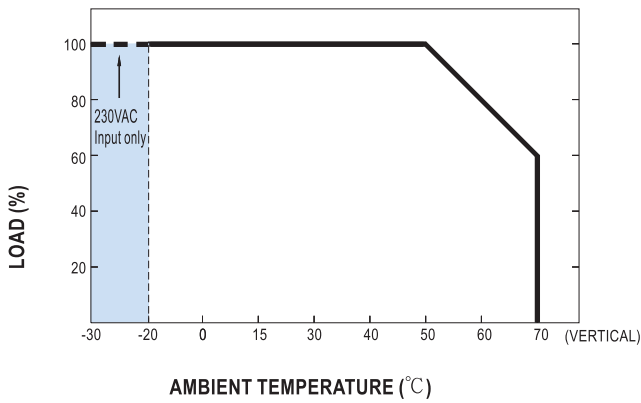

■ **Static Characteristics**

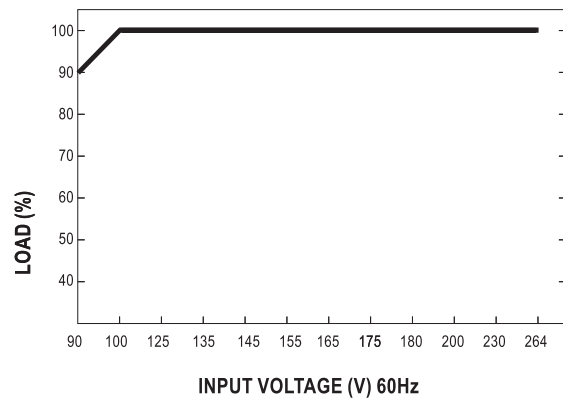

■ **Suggested Application**

1. Back up connection for AC interruption

(1) Please refer to the Fig 1.1 for suggested connection.

The power supply charge the battery and provide energy to the load in the same time when the AC main is OK.

The battery start to supply power to the load when the AC main fails.

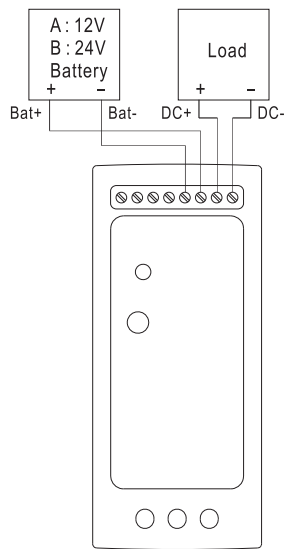

Fig 1.1 Suggested system connection

2. Alarm signal for AC OK and Battery Low

- (1) Alarm signal is sent out through " AC OK " & " Battery Low " pins.(relay contact type)
- (2) An external voltage source is required for this function. The maximum applied voltage is 30V and the maximum sink current is 1A.
- (3) Table 2.1 explain the alarm function built-in the power supply

Function	Description	Output of Alarm
AC OK	The signal is "Low" when the power supply turns on	Low or short
	The signal turns to be "High" when the power supply turns OFF	High or open(External applied voltage 30V max.)
Battery Low	The signal is "Low" when the voltage of battery is under A:11V, B:22V	Low or short
	The signal is "High" when the voltage of battery is above A:11V, B:22V	High or open(External applied voltage 30V max.)

Table 2.1 Explanation of Alarm Signal

AC OK (Battery low)

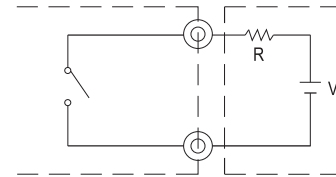

External voltage source (V) and resistor (R)
(The max. Sink is 1A and 30V)

Fig 2.2 Internal circuit of AC OK (Battery Low)

- (4) RL1 (AC OK)signal will go into hiccup mode when the overload protection is activating.

Mechanical Specification

Case No.962A Unit:mm

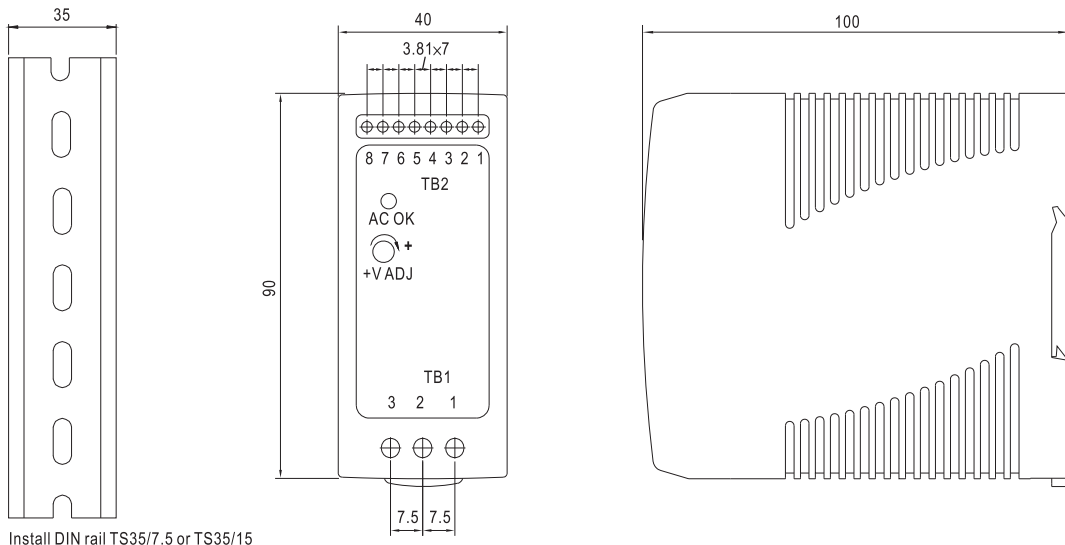

Install DIN rail TS35/7.5 or TS35/15

Terminal Pin No. Assignment (TB1):

Pin No.	Assignment
1	AC/L or DC+
2	AC/N or DC-
3	FG \perp

Terminal Pin No. Assignment (TB2):

Pin No.	Assignment	Pin No.	Assignment
1	-V	4	Bat. -
2	+V	5,6	AC OK
3	Bat. +	7,8	Bat. Low

Installation Manual

Please refer to : <http://www.meanwell.com/webnet/search/InstallationSearch.html>