

Valena™ Life - Valena™ INMATIC
Rotary dimmer 300 W RLC + LEDs

Cat. No(s): 7 521 60 - 7 522 60 - 7 523 60
 7 520 60

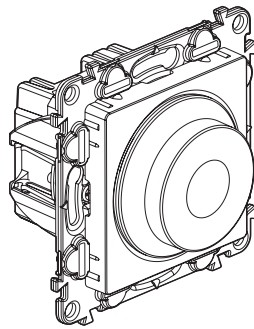

7 521 60 - 7 522 60 - 7 523 60

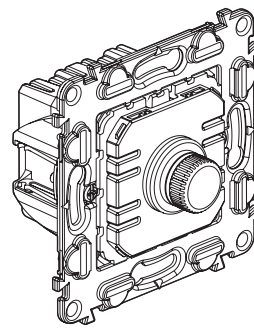

7 520 60

1. USE

Rotary dimming for all types of lamps.
 Can be associated with one or several push buttons, for ON/OFF or dimming control.
 Integrates memory level function: the light switches ON the same level it has been switched OFF.
 Soft-start and soft-stop lighting (2 s).
 Mechanisms to be equipped with plates.
 Screw or claw mounting.

2. RANGE

Description	White	Ivory	Aluminium	Without rocker
Rotary dimmer 300 W - 2-wires Supplied with support frame and rocker plate	7 521 60	7 522 60	7 523 60	-
Rotary dimmer 300 W - 2-wires Supplied with support frame	-	-	-	7 520 60

3. OVERALL DIMENSIONS (mm)

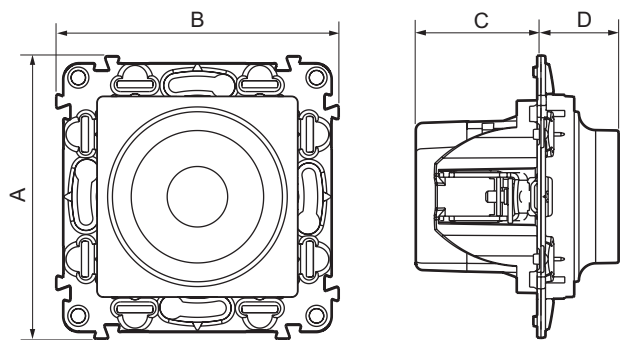

References	A	B	C	D
7 521 60 - 7 522 60 - 7 523 60	75	75	32	21.5
7 520 60	75	75	32	19.5

4. CONNECTION

4 terminals with screws
 Terminal capacity: 2 x 2.5 mm²
 Stripping length: 8 mm

5. INSTALLATION

Simple

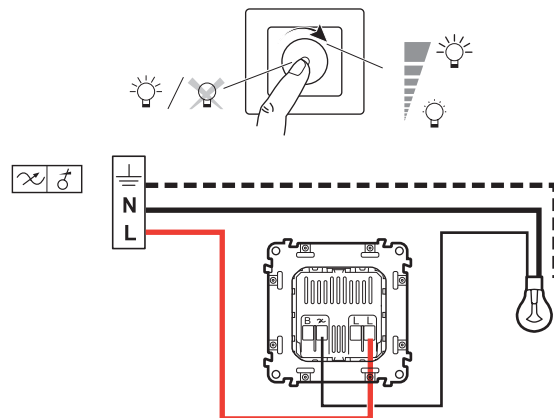

With push buttons

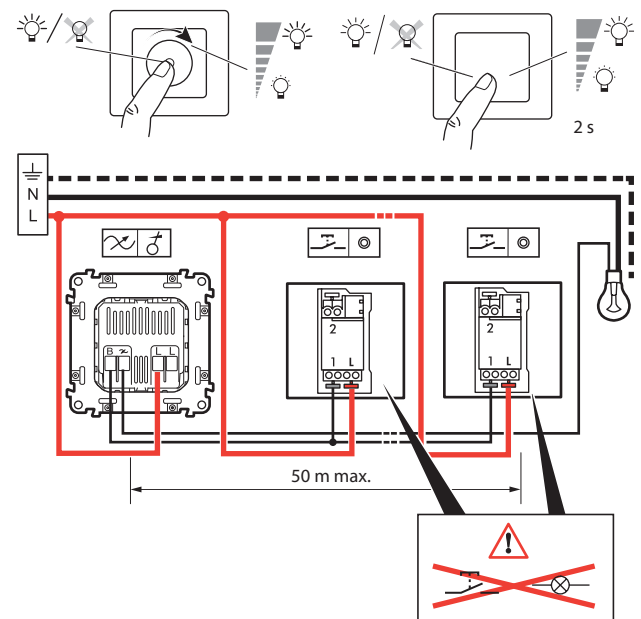

6. TECHNICAL CHARACTERISTICS

■ 6.1 Mechanical characteristics

Protection against solid bodies and liquids: IP 40
Protection against impact: IK 02

■ 6.2 Material characteristics

Polygloss appearance
Colour: - White RAL 9003
- Ivory RAL 1013
- Aluminium

Material: - Front cover: Polycarbonate
- Halogen free
- UV resistant

Material of the support: - Polycarbonate grey RAL 7037
- Halogen free

Self-extinguishing:

+ 850° C / 30 s for insulating parts holding live parts in place
+ 650° C / 30 s for other parts made of insulating materials.















■ 6.3 Electrical characteristics

Voltage: 100 to 240 V~

Frequency: 50-60 Hz

Standby consumption: 0.2 W

● Load table

		R		L		C/L			
									
									
200 V / 240 V	Max.	300 W	300 W	300 VA	300 VA	300 VA	300 VA	75 W or 10 lamps max.	75 W or 10 lamps max.
	Min.	5 W	5 W	5 VA	5 VA	5 VA	5 VA	5 W	5 W
100 V / 200 V	Max.	150 W	150 W	150 VA	150 VA	150 VA	150 VA	37 W or 10 lamps max.	37 W or 10 lamps max.
	Min.	5 W	5 W	5 VA	5 VA	5 VA	5 VA	5 W	5 W

(*)Use only with transformers designed to function with electronic switches.

● Setting C or L

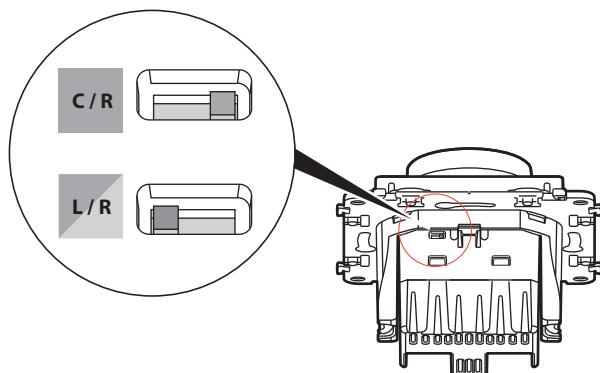

■ 6.4 Climatic characteristics

Storage temperature: - 10° C to + 70° C

Use temperature: 0° C to + 35° C

7. MAINTENANCE

Surface cleaning with a cloth.

Do not use: acetone, tar remover, trichloroethylene.

Maintenance with the following products: Hexane (EN 60669-1), Methylated spirit, Soapy water, Diluted ammonia, Bleach diluted to 10%, Window-cleaning products.

Caution: A preliminary test should be carried out if other specific cleaning products are to be used.

8. STANDARDS AND APPROVALS

Compliance with standard IEC 60669-2-1

Compliance with standards of installation and manufacturing.

Refer to e. catalogue.