



User Manual for

XL4 OCS

HE-XC1E0 / HEXT251C100
HE-XC1E2 / HEXT251C112
HE-XC1E3 / HEXT251C113
HE-XC1E4 / HEXT251C114
HE-XC1E5 / HEXT251C115



MAN0964-01-EN

PREFACE

This manual explains how to use the XL4 OCS.

Copyright (C) 2012 Horner APG, LLC, 59 South State Avenue, Indianapolis, Indiana 46201. All rights reserved. No part of this publication may be reproduced, transmitted, transcribed, stored in a retrieval system, or translated into any language or computer language, in any form by any means, electronic, mechanical, magnetic, optical, chemical, manual or otherwise, without the prior agreement and written permission of Horner APG, Inc.

All software described in this document or media is also copyrighted material subject to the terms and conditions of the Horner Software License Agreement.

Information in this document is subject to change without notice and does not represent a commitment on the part of Horner APG.

Cscape, SmartStack, SmartStix, SmartRail and CsCAN are trademarks of Horner APG.

Ethernet is a trademark of Xerox Corporation.

Micro SD and CompactFlash are registered trademarks of SanDisk Corporation.

For user manual updates, contact Technical Support:

North America:

Tel: (+) (317) 916-4274

Fax: (+) (317) 639-4279

Web: www.heapg.com

Email: techsppt@heapg.com

Europe:

Tel: (+) 353-21-4321-266

Fax: (+) 353-21-4321-826

Web: www.horner-apg.com

Email: tech.support@hornerapg.com

LIMITED WARRANTY AND LIMITATION OF LIABILITY

Horner APG, LLC, ("HE-APG") warrants to the original purchaser that the XL4 (HE-XC/HEXT251) OCS module manufactured by HE-APG is free from defects in material and workmanship under normal use and service. The obligation of HE-APG under this warranty shall be limited to the repair or exchange of any part or parts which may prove defective under normal use and service within two (2) years from the date of manufacture or eighteen (18) months from the date of installation by the original purchaser whichever occurs first, such defect to be disclosed to the satisfaction of HE-APG after examination by HE-APG of the allegedly defective part or parts. THIS WARRANTY IS EXPRESSLY IN LIEU OF ALL OTHER WARRANTIES EXPRESSED OR IMPLIED INCLUDING THE WARRANTIES OF MERCHANTABILITY AND FITNESS FOR USE AND OF ALL OTHER OBLIGATIONS OR LIABILITIES AND HE-APG NEITHER ASSUMES, NOR AUTHORIZES ANY OTHER PERSON TO ASSUME FOR HE-APG, ANY OTHER LIABILITY IN CONNECTION WITH THE SALE OF THIS XL4 OCS module. THIS WARRANTY SHALL NOT APPLY TO THIS XL4 OCS module OR ANY PART THEREOF WHICH HAS BEEN SUBJECT TO ACCIDENT, NEGLIGENCE, ALTERATION, ABUSE, OR MISUSE. HE-APG MAKES NO WARRANTY WHATSOEVER IN RESPECT TO ACCESSORIES OR PARTS NOT SUPPLIED BY HE-APG. THE TERM "ORIGINAL PURCHASER", AS USED IN THIS WARRANTY, SHALL BE DEEMED TO MEAN THAT PERSON FOR WHOM THE XL4 OCS module IS ORIGINALLY INSTALLED. THIS WARRANTY SHALL APPLY ONLY WITHIN THE BOUNDARIES OF THE CONTINENTAL UNITED STATES.

In no event, whether as a result of breach of contract, warranty, tort (including negligence) or otherwise, shall HE-APG or its suppliers be liable of any special, consequential, incidental or penal damages including, but not limited to, loss of profit or revenues, loss of use of the products or any associated equipment, damage to associated equipment, cost of capital, cost of substitute products, facilities, services or replacement power, down time costs, or claims of original purchaser's customers for such damages.

To obtain warranty service, return the product to your distributor with a description of the problem, proof of purchase, post paid, insured and in a suitable package.

ABOUT PROGRAMMING EXAMPLES

Any example programs and program segments in this manual or provided on accompanying diskettes are included solely for illustrative purposes. Due to the many variables and requirements associated with any particular installation, Horner APG cannot assume responsibility or liability for actual use based on the examples and diagrams. It is the sole responsibility of the system designer utilizing the XL4 OCS module to appropriately design the end system, to appropriately integrate the XL4 OCS module and to make safety provisions for the end equipment as is usual and customary in industrial applications as defined in any codes or standards which apply.

Note: The programming examples shown in this manual are for illustrative purposes only. Proper machine operation is the sole responsibility of the system integrator.

INTENTIONALLY LEFT BLANK

TABLE OF CONTENTS

PREFACE	2
For user manual updates, contact Technical Support:	2
LIMITED WARRANTY AND LIMITATION OF LIABILITY	3
ABOUT PROGRAMMING EXAMPLES	3
TABLE OF CONTENTS	5
INTENTIONALLY LEFT BLANK	10
CHAPTER 1: SAFETY / COMPLIANCE	11
1.1 Safety Warnings and Guidelines	11
1.2 Grounding	12
1.3 CE Compliance	12
CHAPTER 2: INTRODUCTION	13
2.1 Visual Overview of XL4 OCS	13
2.1.1 Where to Find Information about the XL4 OCS	13
2.1.2 Four main types of information are covered in the manual.	14
2.1.3 Manual Index	14
2.1.4 Table of Figures	14
2.2 Connectivity to the XL4 OCS	14
2.3 Features of XL4 OCS	14
2.4 Required and Suggested Accessories	15
2.5 Useful Documents and References	16
CHAPTER 3: MECHANICAL INSTALLATION	17
3.1 Overview	17
3.2 Mounting Requirements	17
3.2.1 Mounting Procedures (Installed in a Panel Door)	17
3.3 Mounting Orientation	18
3.3.1 XL4 OCS Mounting Clip	18
3.3.2 XL4 OCS Mounting Orientation	18
3.4 Panel Cut-Out	19
3.5 XL4 Dimensions	19
3.6 Factors Affecting Panel Layout Design and Clearances	20
3.6.1 Clearance / Adequate Space	20
3.6.2 Grounding	20
3.6.3 Temperature / Ventilation	20
3.6.4 Orientation	21
3.6.5 Noise	21
3.6.6 Shock and Vibration	21
3.6.7 Panel Layout Design and Clearance Checklist	21
CHAPTER 4: ELECTRICAL INSTALLATION	23
4.1 Grounding Definition	23
4.2 Ground Specifications	23
4.3 How to Test for Good Ground	23
4.4 Primary Power Port	24
CHAPTER 5: SERIAL COMMUNICATIONS	25
5.1 Overview	25
5.2 Port Descriptions	25
5.3 Wiring and Dip Switches	25
5.4 RS-485 Termination	25
5.5 RS-485 Biasing	25

5.6	Cscape Programming via Serial Port	26
5.7	Ladder-Controlled Serial Communication	26
5.8	Downloadable Serial Communication Protocols	26
CHAPTER 6: CAN COMMUNICATIONS		27
6.1	Overview	27
6.2	Port Description	27
6.3	CAN1 Port Wiring	28
6.4	Cscape Programming via CAN	28
6.5	Ladder-Controlled CAN Communication	28
6.6	Using CAN for I/O Expansion (Network I/O)	28
CHAPTER 7: ETHERNET COMMUNICATION		29
7.1	Ethernet Module Protocols and Features	29
7.2	Ethernet System Requirements	29
7.3	Ethernet Module Specifications	29
7.4	Ethernet Module Configuration	29
CHAPTER 8: COMMUNICATION OPTIONS		35
8.1	Overview	35
8.2	Modem COM Module (XMC) Option	36
CHAPTER 9: REMOVABLE MEDIA		37
9.1	Overview	37
9.2	Micro SD Cards	37
9.3	Micro SD File System	38
9.4	Using the Removable Media Manager	38
9.5	Using Removable Media to Log Data	38
9.6	Using Removable Media to Load and Save Applications	39
9.7	Using Removable Media to View and Capture Screens	39
9.8	Removable Media (RM) Function Blocks in Cscape	39
9.9	Filenames used with the Removable Media (RM) Function Blocks	40
9.10	System Registers used with RM	40
CHAPTER 10: GENERAL I/O		41
10.1	Overview	41
10.2	Removing the XL4 OCS I/O Cover	41
10.3	Model and I/O Overview	42
10.4	Solid-State Digital Outputs	44
10.5	Relay Outputs	44
10.6	Digital Inputs	46
10.7	Analog Inputs	46
10.8	Universal Analog Inputs	47
10.9	Analog Outputs	47
CHAPTER 11: HIGH SPEED I/O (HSC / PWM)		49
11.1	Overview	49
11.3	High Speed Counter (HSC) Functions	50
11.3.1	Frequency	50
11.3.2	Totalize	50
11.3.3	Pulse Width Measurement	50
11.3.4	Period Measurement	51
11.2.5	Quadrature	51
11.3	HSC Functions Register Map	53
11.4	High Speed Output Functions	54
11.4.1	Normal	54
11.4.2	PWM	54
11.4.4	Stepper Function	55
11.5	PWM functions register map	56

11.6	PWM Examples.....	57
11.7	STP Examples	57
CHAPTER 12: SYSTEM SETTINGS AND ADJUSTMENTS.....		59
12.1	System Menu - Overview.....	59
12.2	System Menu – Navigation and Editing.....	60
12.3	System Menu – Details	61
12.4	Touch screen calibration.....	72
CHAPTER 13: USER INTERFACE.....		73
13.1	Overview	73
13.2	Displaying and entering Data.....	73
13.3	Alpha-numeric keypad	74
13.4	Screen Navigation.....	76
13.5	Ladder Based Screen Navigation	76
13.6	Beeper Acknowledgement	77
13.7	Touch (Slip) Sensitivity.....	77
13.8	Alarms	77
13.9	Removable Media	79
13.10	Screen Saver	80
13.11	Screen Brightness.....	81
CHAPTER 14: REGISTERS.....		83
14.1	Register Definitions	83
14.2	Useful %S and %SR registers	84
14.3	Register Map for XL4 OCS I/O.....	87
14.4	Resource Limits	87
CHAPTER 15: CSCAPE CONFIGURATION		89
15.1	Overview	89
15.2	Cscape Status Bar	89
15.3	Establishing Communications.....	90
15.3.1	Communicating via MJ1 Serial Port.....	95
15.3.2	Communicating via On Board Ethernet Port	96
15.5	Configuration.....	97
15.6	Digital Input / HSC Configuration	97
15.7	Digital Output / PWM Configuration	98
15.8	Analog Input Configuration.....	99
15.9	Analog Output Configuration.....	100
CHAPTER 16: FAIL – SAFE SYSTEM		101
16.1	Overview	101
16.2	Settings	102
16.3	Backup / Restore Data.....	102
16.4	AutoLoad.....	106
16.5	AutoRun	108
CHAPTER 17: CLONE UNIT		109
17.1	Overview	109
17.2	Clone:.....	109
17.3	Load Clone.....	111
CHAPTER 18: MAINTENANCE.....		113
18.1	Firmware Updates.....	113
18.2	Backup Battery.....	113
18.2.1	Indications the battery needs replacing.....	113
18.2.2	Battery Replacement.....	114
CHAPTER 19: TROUBLESHOOTING / TECHNICAL SUPPORT.....		115
19.1	Connecting to the XL4 OCS.....	115

19.1.1	Connecting Troubleshooting Checklist (serial port – MJ1 Programming)	116
19.1.2	Connecting Troubleshooting Checklist (USB Port - Mini B Programming)	116
19.1.3	Connecting Troubleshooting Checklist (ETN port programming)	116
19.2	Local Controller and Local I/O	116
19.2.1	Local I/O Troubleshooting Checklist	117
19.3	CsCAN Network	117
19.3.1	CsCAN Network Troubleshooting Checklist	117
19.4	Removable Media	118
19.4.1	Basic Troubleshooting	118
19.5	Technical Support Contacts	118
	Index	119
	Table of Figures	122

Visual Map of major tasks and the key chapters to assist you

FIRST STEP of ANY TASK: DATASHEET			
<p>Each XL4 OCS unit is sent with a datasheet in the box. The datasheet is the first document you need to refer to for model-specific information related to XL4 OCS models such as pin-outs, jumper settings, and other key installation information. Visit our website http://www.heapg.com to obtain updates to datasheets, manuals and user documentation.</p>			
QUICK START	INSTALLATION	PROGRAMMING	TROUBLESHOOTING
Safety / Compliance page 11	Safety / Compliance page 11	Safety / Compliance page 11	Safety / Compliance page 11
Introduction page 13	Introduction page 13	Introduction page 13	Introduction page 13
	Mechanical Installation page 17	Serial Communications Page 25	Maintenance page 113
	Electrical Installation page 23	CAN Communications page 27	Troubleshooting page 115
		Ethernet Page 29	
		Communication Options page 35	
		Removable Media page 37	
		High Speed I/O page 49	
		System Settings page 59	
		User Interface page 73	
		Registers page 83	
		Cscape Configuration page 89	
	Fail- Safe System Page 101		
		Clone Unit Page 109	

INTENTIONALLY LEFT BLANK

CHAPTER 1: SAFETY / COMPLIANCE

1.1 Safety Warnings and Guidelines

When found on the product, the following symbols specify:



Warning: Consult user documentation.



Warning: Electrical Shock Hazard.

WARNING – EXPLOSION HAZARD – Do not disconnect equipment unless power has been switched off or the area is known to be non-hazardous

WARNING: To avoid the risk of electric shock or burns, always connect the safety (or earth) ground before making any other connections.

WARNING: To reduce the risk of fire, electrical shock, or physical injury it is strongly recommended to fuse the voltage measurement inputs. Be sure to locate fuses as close to the source as possible.

WARNING: Replace fuse with the same type and rating to provide protection against risk of fire and shock hazards.

WARNING: In the event of repeated failure, do **not** replace the fuse again as a repeated failure indicates a defective condition that will **not** clear by replacing the fuse.

WARNING – EXPLOSION HAZARD – Substitution of components may impair suitability for Class I, Division 2

WARNING - The USB parts are for operational maintenance only. Do not leave permanently connected unless area is known to be non-hazardous

WARNING – EXPLOSION HAZARD - BATTERIES MUST ONLY BE CHANGED IN AN AREA KNOWN TO BE NON-HAZARDOUS

WARNING - Battery May Explode If Mistreated. Do Not Recharge, Disassemble or Dispose Of In Fire

WARNING: Only qualified electrical personnel familiar with the construction and operation of this equipment and the hazards involved should install, adjust, operate, or service this equipment. Read and understand this manual and other applicable manuals in their entirety before proceeding. Failure to observe this precaution could result in severe bodily injury or loss of life.

- a. All applicable codes and standards need to be followed in the installation of this product.
- b. For I/O wiring (discrete), use the following wire type or equivalent: Belden 9918, 18 AWG or larger.

Adhere to the following safety precautions whenever any type of connection is made to the module.

- a. Connect the green safety (earth) ground first before making any other connections.
- b. When connecting to electric circuits or pulse-initiating equipment, open their related breakers. Do **not** make connections to live power lines.
- c. Make connections to the module first; then connect to the circuit to be monitored.
- d. Route power wires in a safe manner in accordance with good practice and local codes.
- e. Wear proper personal protective equipment including safety glasses and insulated gloves when making connections to power circuits.
- f. Ensure hands, shoes, and floor is dry before making any connection to a power line.
- g. Make sure the unit is turned OFF before making connection to terminals. Make sure all circuits are de-energized before making connections.
- h. Before each use, inspect all cables for breaks or cracks in the insulation. Replace immediately if defective.

1.2 Grounding

Grounding is covered in various chapters within this manual.

1.3 CE Compliance

To check for compliance and updates, visit our website at:

<http://www.heapg.com> or <http://www.horner-apg.com>

CHAPTER 2: INTRODUCTION

2.1 Visual Overview of XL4 OCS

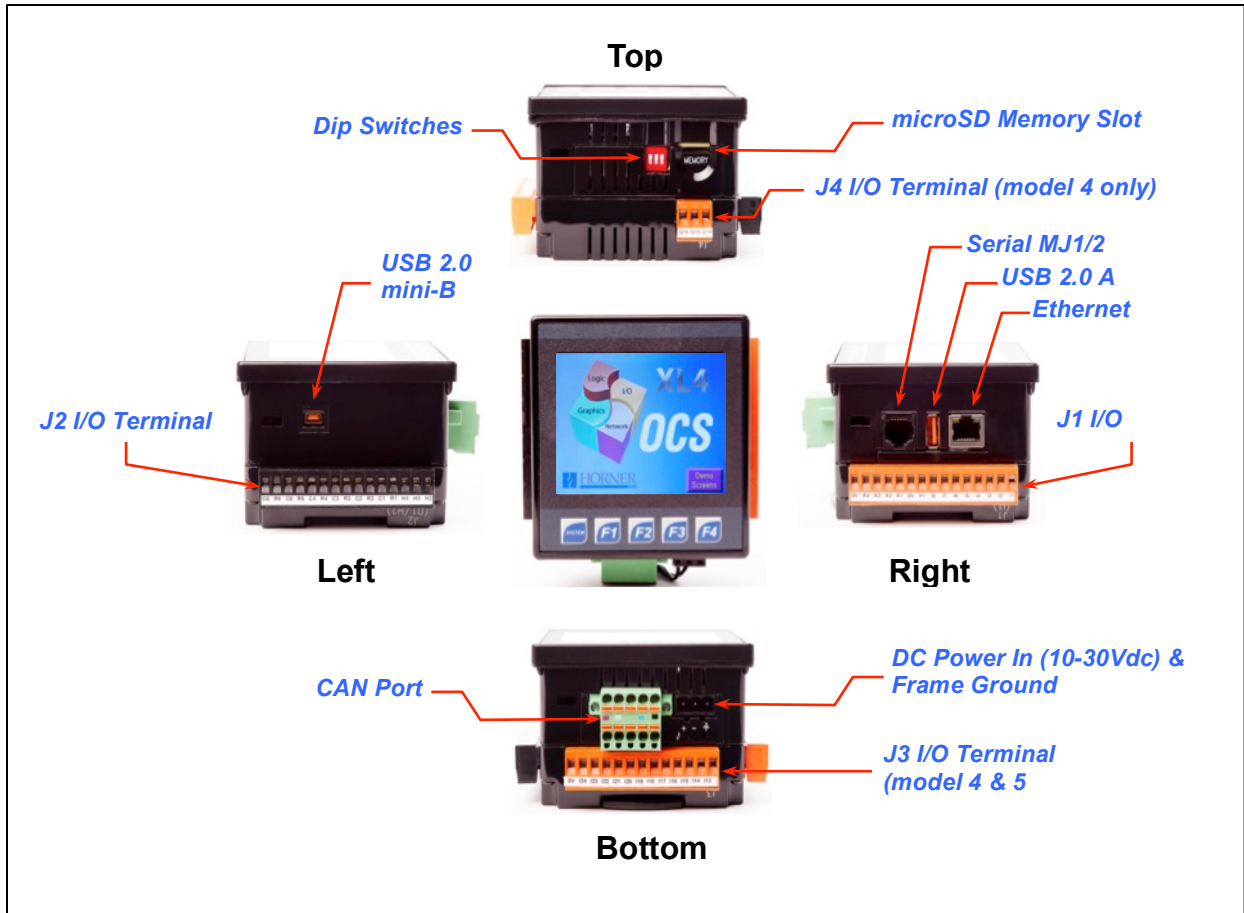

2.1.1 Where to Find Information about the XL4 OCS

- a. **Datasheets** - The **datasheets are the first documents you need to refer to for key information** related to specific XL4 OCS models.

The datasheets for all XL4 OCS models are available on our website.

Datasheets contain pin-outs, jumper settings and other model specific information.

- b. **User Manual** -This manual provides general information that is common to XL4 OCS models and can be downloaded from our web. Visit our website at <http://www.heapg.com> to obtain user documentation and updates.

2.1.2 *Four main types of information are covered in the manual.*

- a. Safety and Installation guidelines / instructions (Mechanical and Electrical)
- b. Descriptions of hardware features
(Serial ports, Removable Media, Communication Options, etc.)
- c. Configuration and Use of the XL4 OCS
- d. Maintenance and Support

2.1.3 *Manual Index*

[Index](#)

Major topics of interest may be found in the [Index](#) towards the end of this manual.

2.1.4 *Table of Figures*

[Table of Figures](#)

Location of important drawing, illustrations (etc) may be found in the [Table of Figures](#) .

2.2 Connectivity to the XL4 OCS

The XL4 OCS has excellent capabilities for connecting to a variety of devices. The diagram below shows some examples of devices that can be used with the XL4 OCS.

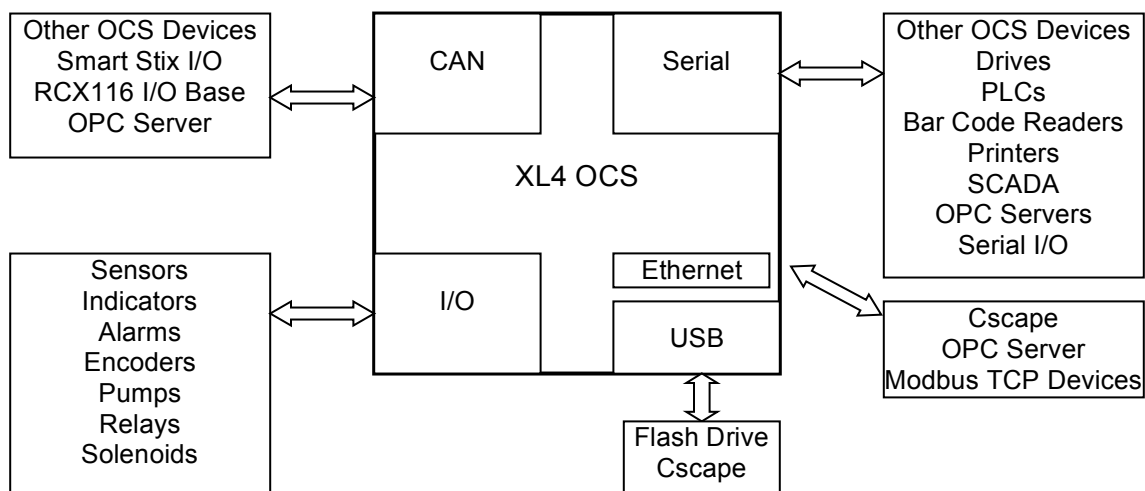

Figure 2.3 – Visual Overview of Types of Devices that can be connected to XL4 OCS

2.3 Features of XL4 OCS

The XL4 OCS are all-in-one industrial control devices. They combine control, user interface, I/O and networking into a single, integrated package. Unique features of the XL4 OCS include:

- Bright, 65536 color graphical touch sensing LCD display in all models of XL4.
- Display of complex graphical objects including trends, gauges, meters and animations.
- Very high performance graphic processing
- Advanced control capabilities including floating point, multiple auto-tuning PID loops and string handling capabilities.

- Removable media for 32 gigabytes of storage of programs, data logging or screen captures.
- CsCAN networking port for communication with remote I/O, other controllers or PCs.
- High speed USB port for communication with PCs and programming of controller.
- Configurable serial protocols for communication to drives, PLCs, or other serial peripherals.
- Full featured, built-in I/O including high resolution analog, thermocouple, RTD, high speed counters, PWM outputs and relays (depending upon the XL4 OCS model used).
- Advanced high speed I/O capabilities
- Cscape programming software that allows all aspects of the XL4 OCS to be programmed and configured from one integrated application.
- Optional communication add-on modules
- On board Ethernet port (10/100Mbps) for Cscape programming and application defined communication, with Auto MDI/MDI-X.

2.4 Required and Suggested Accessories

The following list contains a *sampling* of required and suggested XL4 OCS accessories. Visit our website to view updates on new products and accessories.

Note: The XL4 OCS is not shipped with a programming cable in the box. To obtain a programming cable, order HE500CBL300.

Table 2.1 – XL4 OCS Accessories	
Part Number	Description
HE-XMC	14.4 k Telephone modem option kit - field installable. Kit includes all parts necessary for internal installation within the XL4 OCS case, including a deeper plastic back cover adapted for modem operation.
HE-MC1	Removable Media card - compatible with XL4 OCS. Card capacity is 2 GB or larger.
HE-MR1	Media Card Reader for HE-MC1. Portable device allows HE-MC1 to be plugged into the USB port of personal computers as a portable hard drive.
HE-X24-AS	Power supply 100-240VAC or 140-340VDC Switching supply that outputs 1.5 A / 3 A (HE-X24-AS/AL) at 24 VDC. Mounts on Standard DIN rail. Designed for X Family products.
HE-X24-AL	Power supply 100-240 VAC or 140-340 VDC Switching supply that outputs 1.5 A / 3 A (HE-X24-AS/AL) at 24VDC. Mounts on Standard DIN rail. Designed for X Family products.
HECSP	Cscape Software Package on a reusable USB flash drive with symbol library.
HE-XCK	Programming cables for all X products including a USB to serial adapter in a travel case.
HE-CPK	Cscape on a reusable usb flash drive, Programming cables for all X products including a USB to serial adapter in a travel case.

2.5 Useful Documents and References

The following information serves as a *general* listing of Horner controller products and other references of interest with their corresponding manual numbers. Visit our website to obtain user documentation and updates.

Table 2.2 – OCS Reference Document numbers	
Note: This list is <u>not</u> intended for users to determine which products are appropriate for their application; controller products differ in the features that they support. If assistance is required, refer to Technical Support.	
Controllers	Manual Number
HE-XExxx (XLe and XLt)	MAN0878
XL4	MAN0883
QX Series (e.g., HE-QXxxx)	MAN0798
NX Series (e.g., HE-NXxxx)	MAN0781
Other Useful References	Manual Number
Ethernet Supplement	SUP0740
CAN Networks	MAN0799
Spark Quenchers (output protection)	MAN0962-01-EN
Wiring Accessories and Spare Parts Manual	MAN0347

CHAPTER 3: MECHANICAL INSTALLATION

Note: The datasheet is the first document you need to refer to for model-specific information related to XL4 OCS models such as pin-outs, jumper settings, and other key installation information. Visit our website to obtain datasheets, user documentation, and updates.

3.1 Overview

The mechanical installation greatly affects the operation, safety and appearance of the system. Information is provided to mechanically install the unit such as cut-out sizes, mounting procedures and other recommendations for the proper mechanical installation of the unit.

3.2 Mounting Requirements

3.2.1 Mounting Procedures (Installed in a Panel Door)

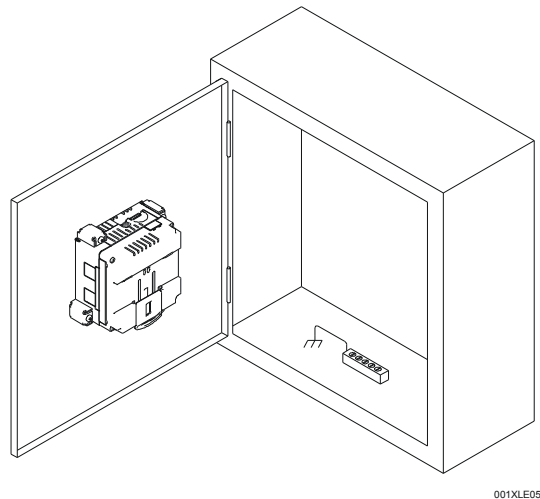

Figure 3.1 – Panel Mounting of an XL4 Series OCS

Once the panel design has been completed using the criteria and suggestions in the following sections, use the following steps to panel mount the XL4 OCS.

1. Remove all connectors from the XL4 OCS unit.
2. Make sure the gasket is installed on the XL4 OCS and is free from dust and debris. Check that the corners of the gasket are secure.
3. Pass the unit through the panel.
4. Insert the each of the four (4) mounting clips into the slots in the XL4 OCS case. One clip should be installed on each corner. Lightly tighten each screw so the clip is held in place.
5. Tighten the screws on the clips such that the gasket is compressed against the panel. Recommended torque is 4 ft lb (5.4 N m).

3.3 Mounting Orientation

3.3.1 XL4 OCS Mounting Clip

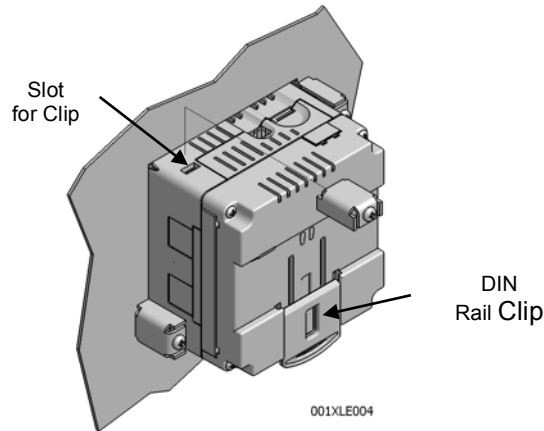

Figure 3.2 – XL4 OCS with Mounting Clips

3.3.2 XL4 OCS Mounting Orientation



NOTE: For panel or DIN rail mounting:
The orientation shown above provides for optimum readability of the screen and ease of use of the keypad.

CAUTION: For DIN Rail mounting:
To prevent the unit from slipping off the DIN Rail, do not install the unit on its sides as shown. Be sure the DIN Rail is in the horizontal position. .

Figure 3.3 – Orientation of XL4 OCS

3.4 Panel Cut-Out

For installations requiring NEMA4X liquid and dust protection the panel cutout should be cut with a tolerance of $\pm 0.005"$ (0.1 mm).

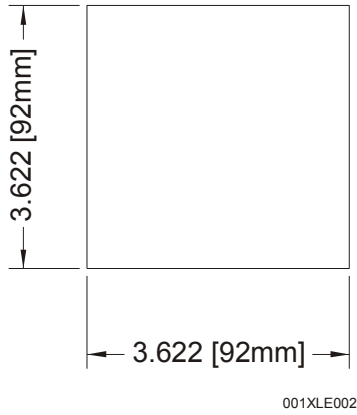

Figure 3.4 – Panel Cutout Tolerances

3.5 XL4 Dimensions

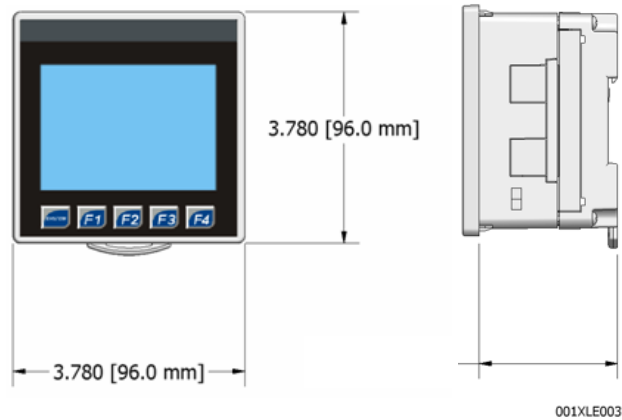

Figure 3.5 – XL4 OCS Dimensions

3.6 Factors Affecting Panel Layout Design and Clearances

Warning: It is important to follow the requirements of the panel manufacturer and to follow all applicable electrical codes and standards.

The designer of a panel layout needs to assess the requirements of a particular system and to consider the following design factors.

3.6.1 Clearance / Adequate Space

Install devices to allow sufficient clearance to open and close the panel door.

Table 3.1 – Minimum Clearance Requirements for Panel Box and Door	
Minimum Distance between base of device and sides of cabinet	2 inches (50.80mm)
Minimum Distance between base of device and wiring ducts	1.5 inches (38.10mm)
If more than one device installed in panel box (or on door): Minimum Distance between bases of each device	4 inches between bases of each device (101.60mm)
When door is closed: Minimum distance between device and closed door (Be sure to allow enough depth for the OCS.)	2 inches (50.80mm)

3.6.2 Grounding

Warning: Be sure to meet the ground requirements of the panel manufacturer and also meet applicable electrical codes and standards.

Panel box: The panel box needs to be properly connected to earth ground to provide a good common ground reference.

Panel door: Tie a low impedance ground strap between the panel box and the panel door to ensure that they have the same ground reference.

3.6.3 Temperature / Ventilation

Ensure that the panel layout design allows for adequate ventilation and maintains the specified ambient temperature range. Consider the impact on the design of the panel layout if operating at the extreme ends of the ambient temperature range. For example, if it is determined that a cooling device is required, allow adequate space and clearances for the device in the panel box or on the panel door.

3.6.4 Orientation

When panel-mounted, there are no orientation restrictions on the XL4 OCS.

3.6.5 Noise

Consider the impact on the panel layout design and clearance requirements if noise suppression devices are needed. Be sure to maintain an adequate distance between the XL4 OCS and noisy devices such as relays, motor starters, etc.

For details on output protection, especially when using contactors, solenoids... see MAN0962-01-EN.

3.6.6 Shock and Vibration

The XL4 OCS has been designed to operate in typical industrial environments that may inflict some shock and vibration on the unit. For applications that may inflict excessive shock and vibration please use proper dampening techniques or relocate the XL4 OCS to a location that minimizes shock and/or vibration.

3.6.7 Panel Layout Design and Clearance Checklist

The following list provides highlights of panel layout design factors:

- Meets the electrical code and applicable standards for proper grounding, etc.?
- Meets the panel manufacturer's requirements for grounding, etc.?
- Is the panel box properly connected to earth ground? Is the panel door properly grounded? Has the appropriate procedure been followed to properly ground the devices in the panel box and on the panel door?
- Are minimum clearance requirements met? Can the panel door be easily opened and closed? Is there adequate space between device bases as well as the sides of the panel and wiring ducts?
- Is the panel box deep enough to accommodate the XL4 OCS?
- Is there adequate ventilation? Is the ambient temperature range maintained? Are cooling or heating devices required?
- Are noise suppression devices or isolation transformers required? Is there adequate distance between the base of the XL4 OCS and noisy devices such as relays or motor starters? Ensure that power and signal wires are not routed in the same conduit.
- Are there other requirements that impact the particular system, which need to be considered?

NOTES

CHAPTER 4: ELECTRICAL INSTALLATION

Note: The datasheet is the first document you need to refer to for model-specific information related to XL4 OCS models such as pin-outs, jumper settings, and other key installation information. Visit our website to obtain datasheets, user documentation, and updates.

4.1 Grounding Definition

Ground: The term **Ground** is defined as a conductive connection between a circuit or piece of equipment and the earth. Grounds are fundamentally used to protect an application from harmful interference causing either physical damage such as by lightning or voltage transients or from circuit disruption often caused by radio frequency interference (RFI).

4.2 Ground Specifications

Ideally, a ground resistance measurement from equipment to earth ground is 0 ohms. In reality it typically is higher. The U.S. National Electrical Code (NEC) states the resistance to ground shall not exceed twenty-five (25) ohms. Horner APG recommends *less than* fifteen (15) ohms resistance from our equipment to ground. Resistance *greater than* twenty-five (25) ohms can cause undesirable or harmful interference to the device.

4.3 How to Test for Good Ground

In order to test ground resistance, a Ground Resistance Tester must be used. A typical Ground Resistance Meter Kit contains a meter, two or three wire leads, and two ground rods. Instructions are supplied for either a two-point or three-point ground test.

Figure 4.1 shows a two-point ground connection test.

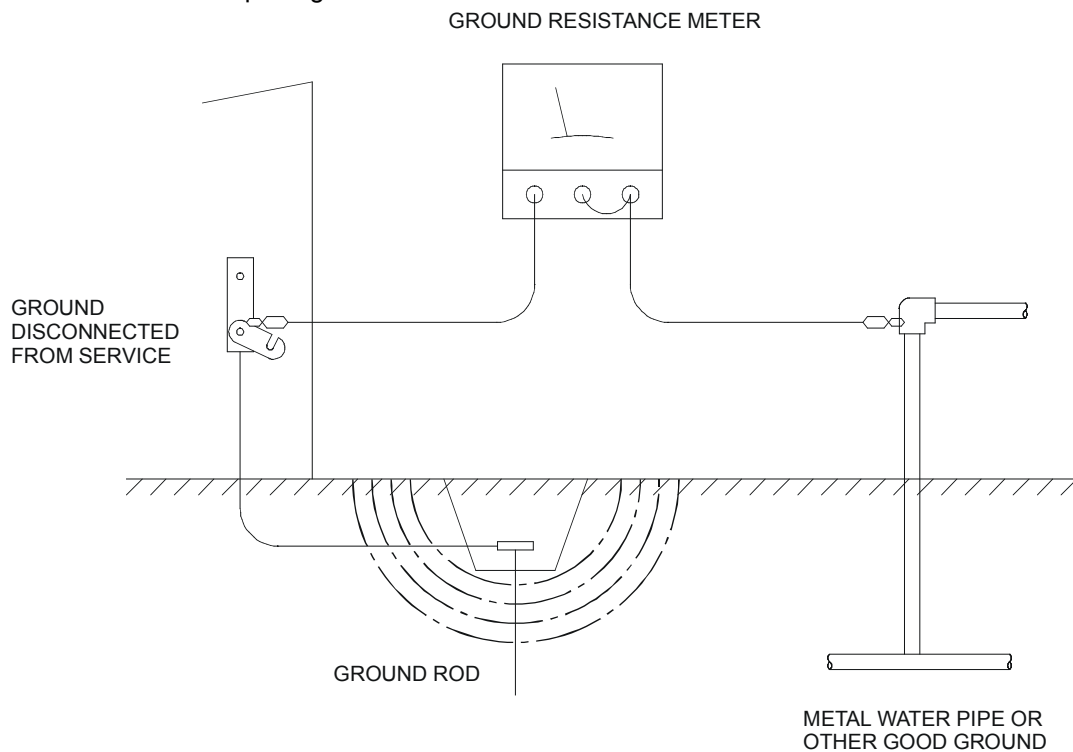



Figure 4.1 – Two-Point Ground Connection Test

4.4 Primary Power Port

Table 4.1 – Primary Power Port Pins		
Pin	Signal	Description
1		Frame Ground
2	0V	Input power supply ground
3	+24V	Input power supply positive voltage

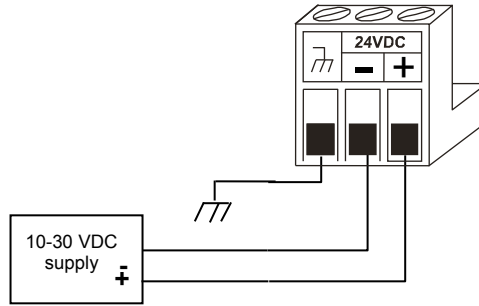

Figure 4.2 – Power Connector (Primary Power Port)

Power Connector

Power Up:
 Connect to Earth Ground.
 Apply 10 – 30 VDC.
 Screen lights up.
 Torque rating 4.5 - 7 Lb-In
 (0.50 – 0.78 N-m)

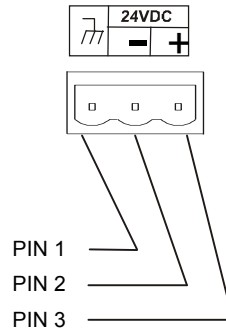

Figure 4.3 – Primary Power Port as Viewed Looking at the XL4 OCS

CHAPTER 5: SERIAL COMMUNICATIONS

5.1 Overview

All XL4 OCS models provide two serial ports, which are implemented with single 8-pin modular RJ45 connectors, and are labeled **MJ1** and **MJ2**. The MJ1 serial port is RS-232 while the MJ2 port is RS-485. MJ1 defaults to OCS programming by connecting it to the COM port of a PC running Cscape. In addition, both MJ1 and MJ2 can be used for application-specific communication, using a variety of standard data exchange protocols.

5.2 Port Descriptions

The MJ1 serial port contains a RS-232 interface with RTS/CTS handshaking.

The MJ2 serial port contains half-duplex RS-485 interface with no handshaking. The MJ2 RS-485 interface provides switchable termination and bias resistors internally.

5.3 Wiring and Dip Switches

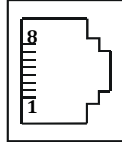

MJ1/2 Serial Ports

MJ1: RS-232 w/Full Handshaking

MJ2: RS-485 Half-Duplex

Two Serial Ports on One Modular Jack (8posn)

Pin	MJ1 Pins		MJ2 Pins	
	Signal	Direction	Signal	Direction
8	TXD	OUT	-	-
7	RXD	IN	-	-
6	0 V	Ground	0 V	Ground
5	+5V@60mA	OUT	+5V@60mA	OUT
4	RTS	OUT	-	-
3	CTS	IN	-	-
2	-	-	RX- / TX-	IN / OUT
1	-	-	RX+ / TX+	IN / OUT

DIP Switches

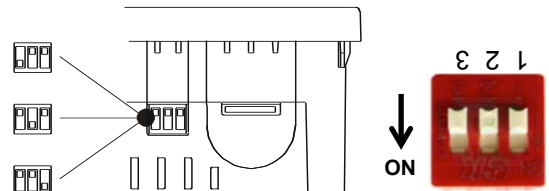

ON

Pin	Name	Function	Default
1	RS-485 Termination	ON = Terminated	OFF
2	Spare	Always Off	OFF
3	Factory Use	Always Off	OFF

5.4 RS-485 Termination

Proper RS-485 termination minimizes reflections and improves reliability.

The 485 serial port allows an internal RS-485 termination resistor to be placed across pins 1 and 2 by DIP Switch Setting.

Only the two devices physically located at the endpoints of the RS-485 network should be terminated.

5.5 RS-485 Biasing

RS-485 biasing passively asserts a line-idle state when no device is actively transmitting, which is useful for multi-drop RS-485 networking.

The 485 serial ports allow internal RS-485 bias resistors to be switched in, pulling pin 1 up to 3.3V and pulling pin 2 down to ground. The Set Serial Ports item in the System Menu can be used to enable RS-485 biasing. Also, an application graphics screen that writes to %SR164 can do the same thing. Setting %SR164.1 enables MJ1 biasing and setting %SR164.2 enables MJ2 biasing.

If biasing is used, it should be enabled in only one of the devices attached to the RS-485 network.

5.6 Cscape Programming via Serial Port

The XL4 OCS MJ1 serial port supports CsCAN Programming Protocol. If a PC COM port is connected to the XL4 OCS MJ1 serial port, Cscape can access the XL4 OCS for programming and monitoring. Programming can also be done via the CAN port, USB port or Ethernet.

5.7 Ladder-Controlled Serial Communication

Using Serial Communication function blocks, both MJ1 and MJ2 support Generic, Modbus Master and Modbus Slave Protocols. In addition, external modems can be connected and accessed using Init, Dial and Answer Modem function blocks.

5.8 Downloadable Serial Communication Protocols

Both MJ1 and MJ2 also support downloadable protocols, such as Allen Bradley DF1, CsCAN Master, GE Fanuc SNP and Modbus Master.

Note: Refer download section of our website for the list of latest supported protocols.

CHAPTER 6: CAN COMMUNICATIONS

Note: For additional CAN information, refer to the CAN Networks manual (MAN0799) on our website.

6.1 Overview

All XL4 OCS models provide a CAN networking port, which is implemented with a 5-pin connector. The connector is labeled **CAN1**.

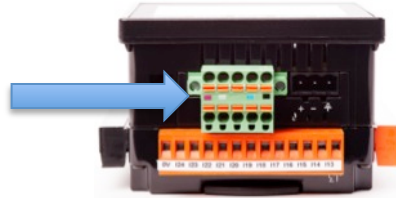

Figure 6.1 – CAN1 Connector

Like the MJ1 serial port, the CAN1 port can be used for XL4 OCS programming by connecting it to the CAN port of a PC running Cscape. The CAN1 port also allows the XL4 OCS to exchange global data with other OCS/RCS controllers and to access remote Network I/O devices (SmartStix, Smart Blocks and Smart Rail Modules).

6.2 Port Description

The XL4 OCS CAN1 port implements the ISO 11898-2 physical layer and the CAN 2.0A data link layer standards. Also, since the CAN1 port is powered by an internal isolated power supply, external CAN power is not required.

6.3 CAN1 Port Wiring

CAN Network & Power Port Pin Assignments				
Pin	Signal	Signal Description	Direction	
1	V-	CAN and Device Ground - Black	-	
2	CN_L	CAN Data Low - Blue	In/Out	
3	SHLD	Shield Ground - None	-	
4	CN_H	CAN Data High - White	In/Out	
5	V+	Positive DC Voltage Input (10-30VDC) - Red	-	

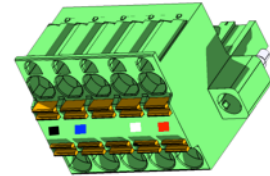

CAN Connector
Use the CAN Connector when using CsCAN or other CAN network.
Torque rating 4.5 – 7 Lb-In

Figure 6.2 – CAN1 Port Connector

6.4 Cscape Programming via CAN

The CAN1 port supports CsCAN Programming Protocol. If a PC has a CAN interface installed (via PCI card or USB), and the PC CAN port is connected to the XL4 OCS CAN1 port, Cscape can access the XL4 OCS for programming and monitoring.

In addition, the XL4 OCS supports single-point-programming of all XL4 OCS and other OCS/RCS devices that are connected to a CAN network. If the PC COM port is connected to the XL4 OCS MJ1 serial port, the XL4 OCS can act as a pass-through gateway allowing Cscape to access all XL4 OCS and OCS/RCS devices that are attached to the CAN network.

6.5 Ladder-Controlled CAN Communication

Using Put and Get Network Words function blocks, the NET1 port can exchange digital and analog global data with other XL4 OCS or OCS/RCS devices (nodes) attached to the CAN network.

In addition, Put and Get Network Heartbeat function blocks allow nodes on the CAN network to regularly announce their presence and to detect the presence (or absence) of other nodes on the network.

6.6 Using CAN for I/O Expansion (Network I/O)

Connecting Network I/O devices (SmartStix, SmartBlocks or SmartRails) to the XL4 OCS CAN1 port, allows the XL4 OCS I/O to be economically expanded and distributed. A variety of modules are available for this purpose.

CHAPTER 7: ETHERNET COMMUNICATION

7.1 Ethernet Module Protocols and Features

The following table describes the Ethernet Module Protocols and features supported by XL4.

Protocol / Feature	Protocol / Feature Description
ICMP Ping	Internet Control Message Protocol
EGD (Peer)	GE Fanuc Ethernet Global Data
SRTP Server	GE Fanuc Service Request Transfer Protocol
CsCAN TCP Server	Horner APG CsCAN over Ethernet
Modbus TCP Slave	Modbus over Ethernet
Ethernet / IP Server	ODVA CIP over Ethernet
FTP Server	File Transfer Protocol
HTTP Server	HyperText Transfer Protocol (Web Server)

7.2 Ethernet System Requirements

Full Ethernet functionality requires:

1. PC running Cscape Programming Software Version 9.3 SP3 or later (for configuration).
2. XL4 controller with onboard Ethernet port.
3. FTP & HTTP protocols.

7.3 Ethernet Module Specifications

Speeds	10 BaseT Ethernet (10-Mbps) 100 BaseTx Fast Ethernet (100-Mbps)
Modes	Half or Full Duplex
Auto-Negotiation	Both 10/100-Mbps and Half/Full Duplex
Connector Type	Shielded RJ-45
Cable Type (Recommended)	CAT5 (or better) UTP
Port	Auto MDI/MDI-X (Auto Crossover)

7.4 Ethernet Module Configuration

Note: The following configuration is required for all applications regardless of the protocols used. Additional configuration procedures must be performed for each protocol used.

To configure the Ethernet Module, use Cscape Programming Software to perform the following steps

1. On the main Cscape screen, select the **Controller** menu and its **I/O Configure** sub-menu to open the I/O Configuration dialog (Figure 7.1)
2. If configuring a different OCS Model than the one shown in the I/O Configuration dialog, click on the topmost **Config** button, select the desired OCS Model, and then click **OK**

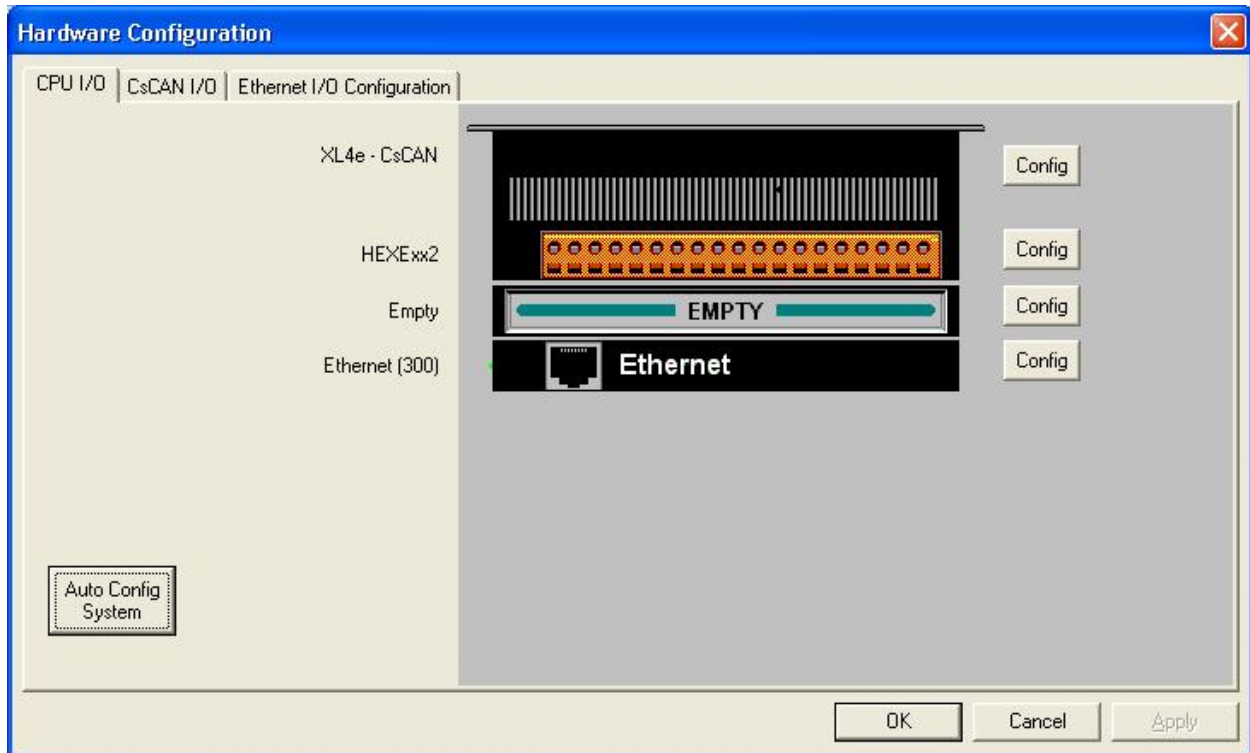

Figure 7.1 – I/O Configuration Dialog

3. Click the **Config** button to the right of the Ethernet Module, and then select the Module Setup tab, revealing the Ethernet Module Configuration dialog as shown in figure 7.2

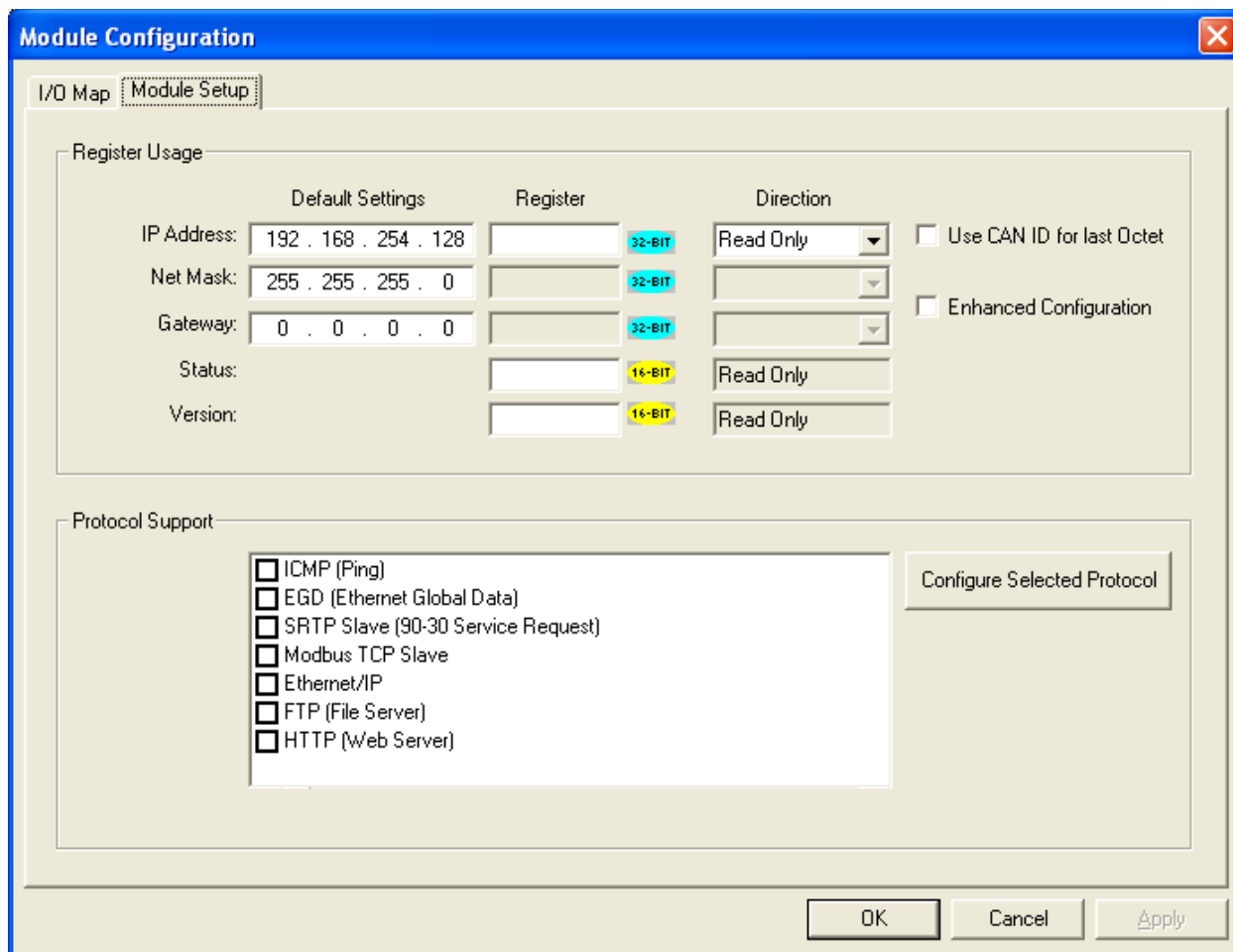

Figure 7.2 – Ethernet Module Configuration

4. Configure the Ethernet Module parameters as follows:

IP Address: Enter the static IP Address for the Ethernet Module being configured.

Note: IP Addresses are entered as four numbers, each ranging from 0 to 255. These four numbers are called octets and they are always separated by decimal points.

Net Mask: Enter the Net Mask (sometimes called Subnet Mask) being used by all nodes on the local network. Typical local networks use Class C IP Addresses, in which case the low octet (rightmost number) is used to uniquely identify each node on the local network. In this case, the default Net Mask value of 255.255.255.0 should be used.

Gateway: Enter the IP Address of a Gateway Server on the local network that allows for communication outside of the local network. To prevent the Ethernet Module from communicating outside the local network, set the Default Gateway IP Address to 0.0.0.0 (the default setting).

Status Register: Enter an OCS Register reference (such as %R100) to indicate which 16-bit OCS register will have the Ethernet Status word written to it. Table 7.1 shows how this register value is formatted and explains the meaning of each bit in the Status Word.

Table 7.1 - Ethernet Status Word Register Format															
High Byte								Low Byte							
Bit 16	Bit 15	Bit 14	Bit 13	Bit 12	Bit 11	Bit 10	Bit 9	Bit 8	Bit 7	Bit 6	Bit 5	Bit 4	Bit 3	Bit 2	Bit 1
0	0	Dup	Spd	0	Rx	Tx	Link	TCP Connections							
Status Bit(s)		Status Indication						Status Values							
0		Reserved						Always 0							
Dup		Link Duplex (Auto-Negotiated)						0 = Half Duplex 1 = Full Duplex							
Spd		Link Speed (Auto-Negotiated)						0 = 10 MHz 1 = 100 MHz							
Rx		Receive State						0 = Inactive 1 = Active							
Tx		Transmit State						0 = Inactive 1 = Active							
Link		Link State						0 = Down 1 = Up							
TCP Connections		Total Number of Active TCP Connections (CsCAN, SRTP, Modbus, EIP, FTP, HTTP)						0 40							

Version Register: Enter an OCS Register reference (such as %R101) to indicate which 16-bit OCS register will have the Ethernet Firmware Version written to it. The value stored in the Version Register is: (Ethernet Firmware Version * 100). For example, for Ethernet Firmware Version 4.30, the Version register will contain 430.

Ethernet Module Register Usage - Standard Configuration

To perform Standard Configuration, simply leave the Enhanced Configuration checkbox unchecked. In this case, **Net Mask** and **Gateway** cannot be assigned to OCS registers, while **IP Address**, **Status** and **Version** must be assigned to OCS registers.

Note that the assigned IP Address register's **Direction** can set to **Read only** or **Read / Write**.

If the register is Read only, the Default IP Address becomes the unit's IP Address and is loaded into the assigned register, where it can be read by the application. (Note: In this case, the low octet of the IP Address can be replaced with the unit's CAN Network ID, by checking the **Use CAN ID for last Octet** checkbox.)

If the register is Read / Write, the application should write an IP Address to the assigned register, and this value will then be the unit's IP Address. (In this case, the Default IP Address is used only if communication is lost during an I/O configuration download; otherwise the Default IP Address is ignored.)

The system menu of the XL4 allows temporarily changing the IP address, net mask and gateway. This is useful for initially communicating with the XL4 for commission or making changes in the field. The Cscape configuration gets priority after a power cycle or transition to RUN.

Ethernet Module Register Usage - Enhanced Configuration

To perform Enhanced Configuration, first check the Enhanced Configuration checkbox. In this case, **IP Address**, **Net Mask**, **Gateway**, **Status** and **Version** can all be optionally assigned to OCS registers. By default, the register edit boxes are empty indicating that no registers are assigned.

As with the IP Address register (described in the Standard Configuration section above), Net Mask and Gateway register **Directions** can be set to **Read Only** or **Read / Write**.

Ethernet Module Register Usage – General

For the Status and Version registers (if configured), the **Direction** settings are always **Read Only**.

The **Use CAN ID for last Octet** checkbox does not affect Net Mask, Gateway, Status or Version configuration.

Ethernet Module Protocol Configuration

The Protocol Support area contains a list of all the protocols supported by the platform being configured. To activate a protocol, check its checkbox.

For protocols that require additional configuration, click on a listed protocol to select it and then click the Configure Selected Protocol button. This will open a new dialog with configuration options for the selected protocol.

For detailed information on individual protocol configuration refer latest version of ETN 300 Manual **SUP0740**

NOTES

CHAPTER 8: COMMUNICATION OPTIONS

8.1 Overview

To supplement the built-in MJ1 and MJ2 serial ports, additional communication options are available. This is accomplished by installing a COM module internal to the XL4 OCS controller.

8.1.1

Previous OCS controllers shared a serial port with the communication options. The XL4 has a separate serial port which allows using both MJ1, MJ2 and the communication options simultaneously. Internal to the XL4 OCS, there is a CPU board, and up to two installed modules. Models **HE-XC100** / **HEXT251C100** have no installed I/O or COM modules. All other models have an I/O module in Slot 1 and could have a user-installed COM module in Slot 2.

This chapter briefly describes the Modem COM module options. For detailed information regarding these modules, please refer to the individual documents provided with the modules.

8.2 Modem COM Module (XMC) Option

A Modem COM module can be installed to allow Cscape programming of an XL4 OCS over a dial-up network. In addition, the application ladder program can take control of the modem for application-specific modem communication.

The Modem COM module supports the standard AT command set and can connect to the dial-up network at speeds up to 14.4 KBaud. Connection speed is auto-negotiated. The Modem COM module connects to the dial-up network (phone line) via a cable with a standard RJ11 modular plug.

To enable Cscape programming via a dial-up network, the Modem COM module should first be configured as the Default Programming Port, using the XL4 OCS System Menu. Doing this puts the Modem COM module in auto-answer mode, so Cscape can call the XL4 OCS via a remote modem.

To program the ladder application to communicate via the Modem COM module, standard Cscape Serial and Modem function blocks can be used.

CHAPTER 9: REMOVABLE MEDIA

9.1 Overview

All XL4 OCS models provide a Removable Media slot, labeled **Memory Card**, which supports standard Micro SD Flash memory cards. Micro SD cards can be used to save and load applications, to capture graphics screens and to log data for later retrieval.

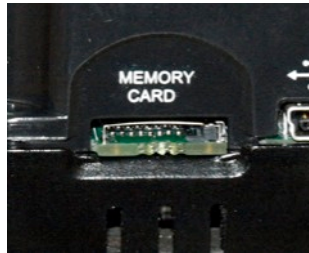

Figure 9.1 – Removable Micro SD Memory Card Slot

9.2 Micro SD Cards

When the Micro SD card format was introduced, it was originally called TransFlash. Cards labeled either Micro SD or TransFlash, with up to 32 GB of Flash memory, are compatible with the XL4 OCS Memory slot (larger sizes were not tested at time of publication).

The Memory slot is equipped with a “push-in, push-out” connector and a Micro SD card can be safely inserted into the Memory slot whether the XL4 OCS power is On or Off.

To install a Micro SD card: Align its 8-pin gold edge connector down, facing the front of the XL4 OCS unit as shown in **Figure 9.2**; then carefully push it all the way into the Memory slot. Ensure that it clicks into place.

To remove the Micro SD card: Push down on the top of the card gently to release the spring. The card pops up for removal.

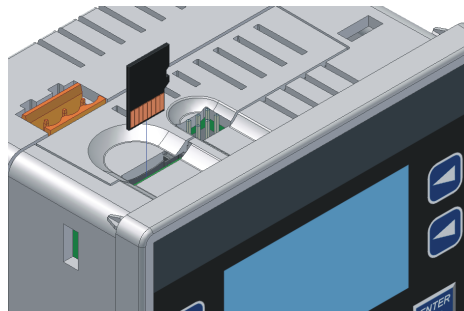

Figure 9.2 – Installing Removable Memory Card

9.3 Micro SD File System

The Micro SD Memory slot uses the PC-compatible FAT32 File System. This means that a PC, with a Micro SD-compatible card reader, can read files that have been written by the XL4 OCS and can write files that can be read by the XL4 OCS.

However, the XL4 OCS does not support long filenames, but instead implements the 8.3 filename format. This means that all file and directory names must consist of up to 8 characters, followed by an optional dot, and an optional extension with up to 3 characters.

Directories and sub-directories can be nested up to 16 levels deep as long as each pathname string does not exceed 147 characters.

9.4 Using the Removable Media Manager

The Removable Media Manager is an interactive XL4 OCS screen that performs the following functions:

- Display number of total and free K bytes
- Browse file and directory lists
- Delete files and directories
- Format a Micro SD card
- Load and save application programs
- View screen capture bitmaps

The Removable Media Manager can be accessed via the System Menu or by using Cscope to place a Removable Media Manager object on an application graphics screen.

Media Directory			
SCR0000	.JPG	26267	07-10-08 12:46
SCR0001	.JPG	14272	07-10-08 12:46
SCR0002	.JPG	15209	07-10-08 12:46
SCR0003	.JPG	29708	07-10-08 12:46
SCR0004	.JPG	29582	07-10-08 12:47
SCR0005	.JPG	23263	07-10-08 12:47
SCR0006	.JPG	14643	07-10-08 12:47
SCR0007	.JPG	14976	07-10-08 12:47
SCR0008	.JPG	15994	07-10-08 12:47
SCR0009	.JPG	17561	07-10-08 12:47
Free:	511672320	Total:	511959040
←	△	▽	Del
	Del All	For mat	Save Pgm
			Esc

Figure 9.3 – Removable Media Submenu

9.5 Using Removable Media to Log Data

Using Read and Write Removable Media function blocks, an application ladder program can read and write XL4 OCS register data in the form of comma-delimited files, with a .CSV extension. These files are compatible with standard database and spreadsheet PC programs. In addition, an application ladder program can use Rename and Delete Removable Media function blocks to rename and delete files.

9.6 Using Removable Media to Load and Save Applications

A special file type, with a .PGM extension, is used to store XL4 OCS application programs on Micro SD.

To load an application from Micro SD to the XL4 OCS, use the Removable Media Manager (open the Removable Media Manager in the System Menu) to find and highlight the desired .PGM file, and then press the Enter key. 

To save an application from the XL4 to Micro SD, open the Removable Media Manager in the System Menu and press the Save Pgm  function key. The application will be saved in a file called **DEFAULT.PGM** in the Micro SD root directory.

Note: Saving an application to Micro SD can only be done from the Removable Media System Menu and is not available on a Removable Media Manager object that was placed on an application graphics screen by Cscope.

Cscope can also save an application directly to a Micro SD card, which is plugged into the PC's Micro SD compatible card reader by selecting the Export to Removable Media item on the Cscope File menu.

9.7 Using Removable Media to View and Capture Screens

The XL4 OCS File System uses bitmap files with the .BMP extension or JPEG files with the .JPG extension to store XL4 OCS graphic screen captures.

To view a captured XL4 OCS screen, use the Removable Media Manager to find and highlight the desired .BMP or .JPG file, and then press Enter. 

To capture an XL4 OCS screen, turning On the assigned **Screen Capture Control Register** will capture the current XL4 OCS graphics screen and write it to the Micro SD card using the assigned **Screen Capture Filename**.

Before capturing an XL4 OCS screen, Cscope must first be used to assign a **Screen Capture Control Register** and **Filename** in the application. To do this, first open the Graphics Editor by selecting the **View / Edit Screens** item on the Cscope **Screens** menu. Next select the **Screen Capture** item of the Graphics Editor Config menu and then enter a **Control Register** and **Filename**.

9.8 Removable Media (RM) Function Blocks in Cscope

Note: For detailed information regarding RM function blocks and parameters, refer to the help file in Cscope Software. Refer 'USB Flash Media support for RM Functions' for USB flash drive access details.

The following RM functional blocks are available in Cscope Software. These function blocks will reference

- Micro SD when filename is prefixed with 'A:' or nothing OR
- USB A Flash Drive when filename is prefixed with 'B:'.

a. Read RM csv

This function allows reading of a comma-separated value file from the Micro SD interface into the controller register space.

b. Write RM csv

This function allows writing of a comma-separated value file to the Micro SD interface from the controller register space.

c. **Rename RM csv:** This function allows renaming a file on the RM card. The data in the file is not changed.

d. **Delete RM csv:** This function allows deleting a file on the RM card.

e. **Copy RM csv:** This function allows copying a file on the RM card. The data in the file is not changed.

9.9 Filenames used with the Removable Media (RM) Function Blocks

The RM function blocks support the flash with a DOS/Windows standard FAT-16 file system. All names must be limited to the "8.3" format where the filename contains eight characters a period then a three-character extension.

The entire filename including any path must be less than or equal to 147 characters.

When creating filenames and directories it is sometimes desirable to include parts of the current date or time. There are six special symbols that can be entered into a filename that are replaced by the OCS with current time and date information.

Table 8.1 – Filename Special Symbols		
Symbol	Description	Example
\$Y	Substitutes the current 2 digit year	2004 = 04
\$M	Substitutes the current month with a 2 digit code	March = 03
\$D	Substitutes the current day	22 nd = 22
\$h	Substitutes the current hour in 24 hour format	4 pm = 16
\$m	Substitutes the current minute	45 = 45
\$s	Substitutes the current second	34 = 34

Note that all the symbols start with the dollar sign (\$) character. Date symbols are in upper case, time symbols are in lower case. The following are examples of the substituted time/date filenames:

Current date and time: March 1, 2004 3:45:34 PM

Filename: Data\$M\$D.csv = Data0301.csv

Filename: Year\$Y\Month\$M\aa\$D_\$h.csv = Year04\Month03\aa01_15.csv

Filename: Month_\$M\Day_\$D\h_\$m_\$s.csv = Month_03\Day_01\15_45_34.csv

9.10 System Registers used with RM

%SR175 Status – This shows the current status of the RM interface.

%SR176 Free Space – This 32-bit register shows the free space on the RM card in bytes.

%SR178 Card Capacity – This 32-bit register shows the total card capacity in kilobytes.

Possible status values are shown in the table:

Table 8.2 – RM Status Values	
0	RM interface OK
1	Card present but unknown format
2	No card in slot
3	Card present, but not supported
4	Card swapped before operation was complete
5	Unknown error

CHAPTER 10: GENERAL I/O

Note: Each XL4 OCS unit is sent with a datasheet in the box. The datasheet is the first document you need to refer to **for model-specific information related to XL4 OCS models such as pin-outs, jumper settings, and other key installation information**. Visit our website to obtain datasheets, user documentation, and updates.

10.1 Overview

The XL4 OCS is a compact unit that contains high density, very versatile I/O. Using the I/O properly requires wiring to the proper terminals, configuring jumpers inside the XL4 OCS unit and configuring Cscope properly. This section will offer some tips and suggestions to configure the I/O properly. For the register mapping of the I/O, refer to the [Index](#) at the end of this manual for the pages referencing register mapping.

10.2 Removing the XL4 OCS I/O Cover

Warning: Power, including I/O power *must be removed* from the unit prior to removing the back cover. Failure to do so could result in electrocution and/or damage to equipment.

Some I/O configurations require jumper settings to be changed inside the XL4 OCS unit. Examples of these settings are setting positive or negative logic on digital inputs or setting current or voltage on analog inputs.

Each XL4 OCS I/O jumper is set to a factory default. Refer to the data sheet for your XL4 OCS model to find the default setting to determine if a jumper change is necessary for your application.

To remove the I/O cover of the XL4 OCS, remove the four (4) Phillips screws from the I/O back. It may help to place the XL4 OCS unit face down on a clean work surface. Once the four screws are removed the I/O cover can be lifted straight off.

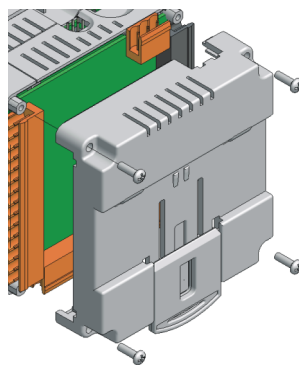

Figure 10.1 – Removing the I/O Cover

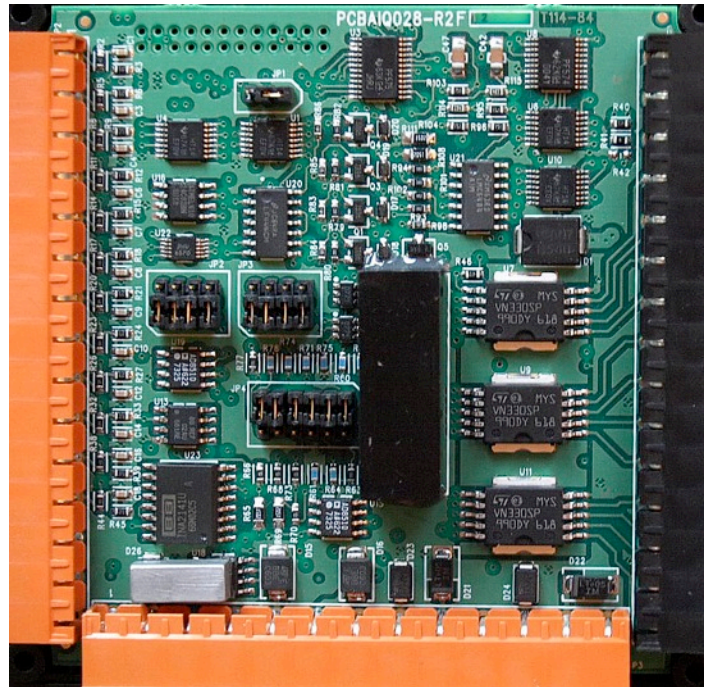

Figure 10.3 – XL4 I/O Cover Removed (sample I/O board)

Once the back is removed the jumper selection can be changed. The jumper settings are documented on each data sheet using a diagram such as Figure 9.4 below and a description of the jumper settings.

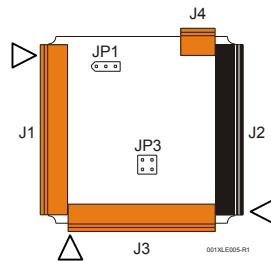

Figure 10.4 – Example Jumper Diagram

To re-install the cover, place the I/O cover back on the unit.

Place the screw back into the hole and turn the screw slowly counter clockwise until it clicks into the threads. This prevents the screw from being cross-threaded. Now turn the screw clock-wise until the cover is firmly secured. Repeat this process for all four (4) screws.

10.3 Model and I/O Overview

Table 10.1 – I/O and Model Overview						
Model (XL4)	Solid State Digital	Relay Outputs	Digital Inputs	Analog Inputs	Universal Analog Inputs	Analog Outputs

	Outputs					
HE-XC1E0 / HEXT251C100						
HE-XC1E2 / HEXT251C112		✓	✓	✓		
HE-XC1E3 / HEXT251C113	✓		✓	✓		
HE-XC1E4 / HEXT251C114	✓		✓	✓		
HE-XC1E5 / HEXT251C115	✓		✓		✓	✓

Table 10.1 shows the different types of I/O included with the various XL4 OCS models. Specific specifications, jumper settings and wiring diagrams can be found on the data sheets attached at the end of the manual. Descriptions and applications of the different type of I/O can be found below.

10.4 Solid-State Digital Outputs

Solid-state digital outputs are generally used to activate lamps, low voltage solenoids, relays and other low voltage and low current devices.

Note: *The digital outputs used on the XL4 OCS are “sourcing” outputs.* This means the output applies a positive voltage to the output pin when turned ON. When turned off, the output applies approximately zero volts with respect to the I/O ground.

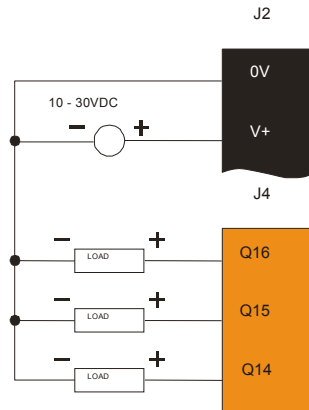

Figure 10.5 – Typical Output Wiring

The digital outputs used in the XL4 OCS have electronic short circuit protection and current limiting. While these electronic protections work in most applications, some application may require external fusing on these outputs.

The digital outputs in the XL4 OCS are typically controlled via %Q bits in the register mapping. Some of the outputs are designed for high-speed applications and can be used for PWM or frequency output applications. Please see the data sheet and the chapter on High Speed I/O for additional information.

When the controller is stopped the operation of each output is configurable. The outputs can hold the state they were in before the controller stopped or they can go to a predetermined state. By default digital outputs turn off. For more information on stop state see the [Index](#) to find pages referencing Cescape settings.

The digital outputs feature an output fault bit. %I32 will turn on if any of the outputs experience a short circuit, over-current or the output driver overheats.

10.5 Relay Outputs

Relay outputs are designed to switch loads that typically have high voltage or current requirements or require isolation that relays provide.

Note: *The design of the XL4 OCS does not require external coil power for the relays to function.* The relays will activate anytime the XL4 OCS is powered.

There are several factors that should be considered when using relays.

Relay Life – Relays are mechanical devices that have a long but limited life. Typically, switching more current limits the life of relays. Please check the data sheets at the end of this manual for expected relay life.

Current / Temperature De-Rating – Products containing relays often have total current limits based on the ambient temperature of the application. Please see the product data sheet for current / temperature de-rating information for relays.

Fusing – External fusing is generally required to protect the relays, devices and wiring from shorts or overloads.

Warning: To protect the module and associated wiring from load faults, use external (**5 A**) fuse(s) as shown. Fuses of lower current or fusing for the entire system need to be in place to assure the maximum current rating of the unit is not exceeded.

Warning: Connecting high voltage to any I/O pin can cause high voltage to appear at other I/O pins.

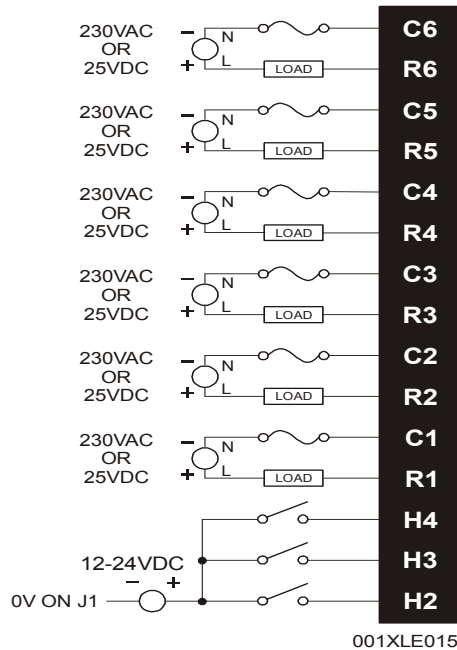

001XLE015

Figure 10.6 – Relay Fusing

Protection for Inductive Loads – Inductive loads can cause reverse currents when they shut off that can shorten the life of relay contacts. Some protective measures need to be determined by an engineer. Below you will find recommendations that will work for many applications. If you have additional questions on protection from inductive load, consult an application engineer or HEAPG Technical Support. Details on devices that may protect outputs can be found in MAN0962-01.

Output State on Controller Stop

When the controller is stopped the operation of each output is configurable. The outputs can hold the state they were in before the controller stopped or they can go to a predetermined state. By default relay outputs turn off. For more information on stop state see the [Index](#) for Cscape settings pages.

10.6 Digital Inputs

Note: Refer to the datasheet for XL4 OCS model you are using for details on jumper settings.

Note: The digital inputs on the XL4 OCS are designed for low voltage DC inputs. The inputs are designed to support both positive and negative input modes. The mode is set by a jumper setting and a configuration parameter in Cscape. All the inputs on the unit must be configured to the same mode.

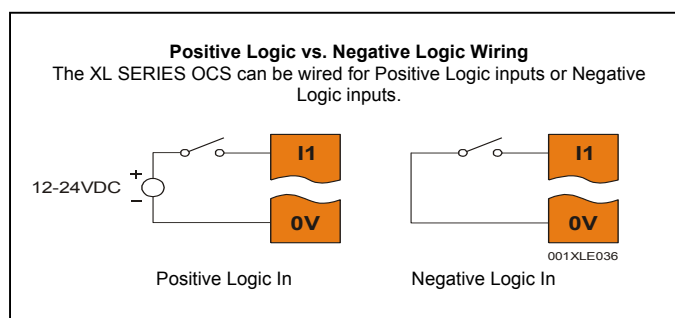

Figure 10.7 – Positive and Negative Inputs

In positive logic mode a positive voltage applied to the input will turn the input. The internal design of this mode is basically a resistor from the input to I/O ground. This mode is sometimes called sourcing.

In negative logic mode, connecting the input to the I/O ground or zero volts will turn the input on. The internal design of this mode is basically a resistor from the input to the positive I/O voltage (usually 12 or 24 volts). This mode is sometime called sinking.

Some of the digital inputs may support high speed input functional such as counting or frequency measurement.

10.7 Analog Inputs

Note: See the data sheet for the XL4 OCS model you are using for jumper settings and see the appropriate page in this manual (see [Index](#)) for details on how to use Cscape to configure the digital filtering.

The analog inputs on the XL4 OCS allow voltage or current measurement from a variety of devices. The voltage or current mode is set though jumpers on the unit and settings in Cscape. Each channel can be separately configured for voltage or current mode.

The analog inputs have a digital filter that can be used to filter electrical noise that may be unavoidable in some installations. The downside to digital filtering is the inputs will respond more slowly to sudden changes in the actual input.

10.8 Universal Analog Inputs

Note: See the data sheet for the XL4 OCS model you are using for jumper settings and see the appropriate pages in this manual (see [Index](#)) for details on how to use Cscape to configure the digital filtering.

The universal analog inputs provide a high resolution, very flexible interface for a variety of analog inputs. These inputs include voltage, current, thermocouple, RTD and millivolt. Each channel can be configured separately using jumpers and configuration settings in Cscape.

Like the standard analog inputs, these inputs have a digital filter that can be used to filter electrical noise that may be unavoidable in some installations. The downside to digital filtering is the inputs will respond more slowly to sudden changes in the actual input.

10.9 Analog Outputs

Note: Refer to the datasheet for XL4 OCS model you are using for details on jumper settings.

The analog outputs on XL4 OCS devices provide high resolution voltage or current outputs. The voltage or current selection is controlled with jumpers and configuration settings in Cscape. Note that each channel can be separately configured for voltage or current mode.

When the controller is stopped the operation of each output is configurable. The outputs can hold the state they were in before the controller stopped or they can go to a predetermined value. By default analog outputs are set to a value of zero. For more information on Stop State, refer to the appropriate pages (see [Index](#)) for the configuration chapter for Cscape settings.

CHAPTER11: HIGH SPEED I/O (HSC / PWM)

11.1 Overview

In addition to the compliment of simple analog and digital I/O, several of the XL4 OCS I/O modules support High Speed Counting (HSC) I/O functions and may also support Pulse Width Modulation (PWM) Output functions (non-relay modules). The HSC functions include: internal timing, frequency, totalizing, pulse width/period and quadrature measurement. The PWM functions include: traditional PWM (with variable rate and duty cycle) and a stepper (limited functionality) with variable acceleration and deceleration rates. To determine function availability, refer to the associated model's Specification/Installation sheet (Digital DC Input/Output sections).

This chapter describes the operation of these high level I/O functions. For configuration details of these functions, see Cscape Configuration.

11.2 Glossary

Accumulator	Register used to accumulate or store up a sum or count of many items or events.
Clear	A special function to zero out the value in a specific register. (Not used with Frequency or Period Measurement.)
Disable	A special function to prevent the counter from running.
Encoder	A sensor or transducer for converting rotary motion or position to a series of electronic pulses
Frequency Input	The number of times an electromagnetic signal repeats an identical cycle in a unit of time, usually one second.
Latch (strobe)	A special function that uses a digital logic circuit to store one or more bits. A latch has a data input, a clock input and an output. When the clock input is active, data on the input is "latched" or stored and transferred to the output register either immediately or when the clock input goes inactive. The output retains its value until the clock goes active again.
Marker	Input into the OCS that indicates a particular position. Typically an encoder has a marker output that represents a specific point in the rotation.
Polarity	A Polarity pull-down box is associated with each function and indicates the manner in which the trigger happens (e.g., High level, Low Level, Falling Edge, Rising Edge).
Preload (load)	A special function used to trigger loading of a value into a register upon an event. (Not used with Frequency or Period Measurement.)
Quadrature	A high speed device that expresses the phase relationship between two periodic quantities of the same period when the phase difference between them is one fourth of a period. A coupler in which the two output signals are 90° out of phase.
Totalizer	A counter that sums the total number of cycles applied to its input.

11.3 High Speed Counter (HSC) Functions

The XL4 supports two very high speed, configurable counters. There are four dedicated inputs that can be configured to a number of different options. Each of the two counters can run in one of five modes. Those modes are Totalizer, Frequency Counter, Pulse Width Measurement, Period Measurement and Quadrature measurement. For some modes, more than one HSC input may be consumed. The measurement values are provided to ladder in a %AI register (see mapping below).

11.3.1 Frequency

In frequency mode, the frequency of the input signal is written to the accumulator in terms of Hertz (cycles/second). When using frequency mode, four update selections are provided which specify the width of the sample window. Note that selecting a shorter sample window provides a quicker measurement (faster response) but lowers the frequency accuracy (resolution) and increases the minimum frequency measurement limit. In this mode the Disable and Latch special functions are allowed. Please see section 11.2 for a description of these functions.

11.3.2 Totalize

In totalize mode, the accumulator is simply incremented or decremented each time the input transitions in a specific direction.

There are five different modes the totalizer can run:

Internal – This mode ties the input to the counter to an internal 10MHz or 1MHz clock. The special functions can be used to accurately time events.

Count Up – This increments the accumulator when the input is enabled. Note that two inputs can be assigned. Either input can cause the counter to increment. The second input can also be disabled.

Count Down - This decrements the accumulator when the input is enabled. Note that two inputs can be assigned. Either input can cause the counter to decrement. The second input can also be disabled.

Up/Down (Input 1 UP/Input 2 Down) – In this mode, input one(assigned to any of the four inputs) increments the counter, while input 2 (also assigned to any of the 4 inputs) decrements the counter.

Clk/Dir (Input 1 Clk, Input 2 Dir) – This mode uses input 1 as a clock signal to increment or decrement the counter and then uses input 2 to decide the direction. Input 2 disabled increments the counter, while input 2 enabled decrements the counter.

Note, the totalize mode enables the Disable, Latch, Preload, and Clear special functions. Please see section 11.2 for details.

11.3.3 Pulse Width Measurement

In pulse width measurement mode, the high-speed input can measure the width of a pulse stream in one of two modes and provides a continuous indication of the last sampled value. In this mode the Disable and Latch special functions are allowed. Please see section 11.2 for a description of these functions.

Width High 1 μ s Counts – In this sub-mode the accumulator value will contain the number of 1 μ s counts the pulse is high.

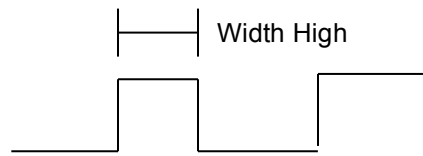

Width Low 1 μ s Counts - In this sub-mode the accumulator value will contain the number of 1 μ s counts the pulse is low.

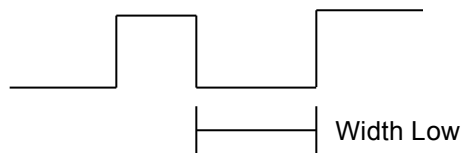

11.3.4 Period Measurement

In period measurement mode, the high-speed input can measure the period of a pulse stream in one of two modes and provides a continuous indication of the last sampled value. In this mode the Disable and Latch special functions are allowed. Please see section 11.2 for a description of these functions.

Period Rising Edges 1 μ s Counts – In this sub-mode the period of the input signal is reported in one (1) μ s units. The period measurement will start on the rising edge of the input.

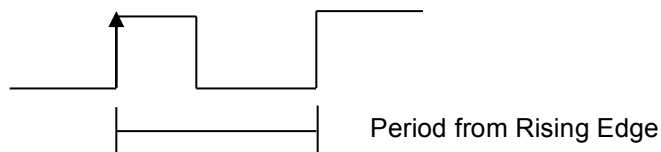

Period Falling Edges 1 μ s Counts – In this sub-mode the period of the input signal is reported in one (1) μ s units. The period measurement will start on the falling edge of the input.

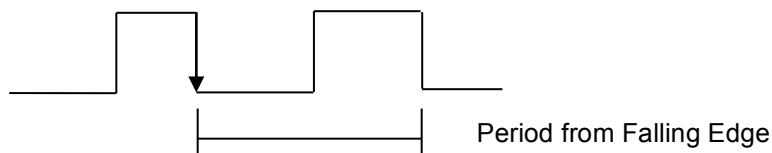

11.2.5 Quadrature

Quadrature mode uses two HSC inputs, any of the four HSC inputs can be assigned for this purpose.

Quadrature mode works much like the totalizer except the accumulator will automatically increment or decrement based on the rotation phase of the two inputs. See the following example for more details. Quadrature inputs are typically used for reporting the value of an encoder.

Two modes are available for quadrature that select whether the accumulator counts up or down when the phase of input 1 leads input 2. Check your encoder's documentation to determine the output form it uses or try both modes to determine if the encoder counts up when expected.

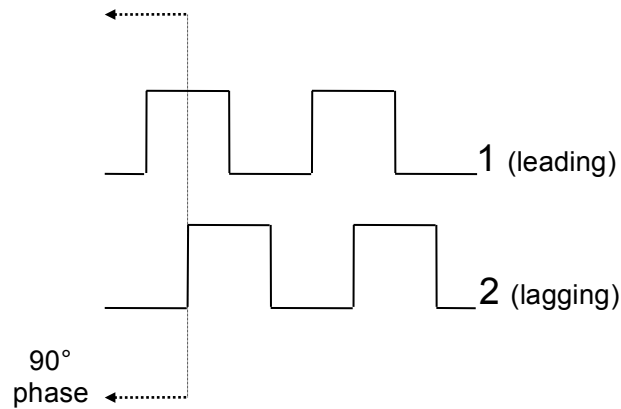

Using the above waveforms and a HSC input configuration of “Quadrature” - “1 leads 2, count up,” the accumulator will count up when 1 is rising and 2 is low, 1 is high and 2 is rising, 1 is falling and 2 is high, and when 1 is low and 2 is falling. This results in 4 counts per revolution. So in order to determine the number of cycles, the accumulator would have to be divided by 4.

Marker reset operation is configured in the special operations and can be assigned to any of the 4 high speed inputs or can be assigned to be controlled by a “Q” bit in ladder.

Note, the quadrature mode enables the Disable, Latch, Preload, Clear and Marker special functions. Please see section 11.2 for details.

11.2.6 Register Match

All counter modes support a register match function. When the accumulator value matches the Match 1 or Match 2 value setup in %AQ registers a high speed output with either turn on, turn off or toggle based on settings in Cscope.

11.3 HSC Functions Register Map

The register assignments for the high speed I/O can be moved via a setting in Cscope. The values shown are the DEFAULT values and may not match the same starting point as the values shown below.

Register	Frequency	Pulse	Totalize	Quad
%AI401-402			Accumulator - Counter 1	
%AI403-404			Latch Value – Counter 1	
AI405-406			Accumulator – Counter 2	
%AI11-12			Latch Value – Counter 2	
%AQ401-402			Preload – Counter 1	
%AQ403-404			Match1 – Counter 1	
%AQ405-406			Match2 – Counter 1	
%AQ401-402			Preload – Counter 2	
%AQ403-404			Match1 – Counter 2	
%AQ405-406			Match2 – Counter 2	
%Q1601			Latch – Counter 1	
%Q1602			Preload – Counter 1	
%Q1603			Clear – Counter 1	
%Q1604			Disable – Counter 1	
%Q1605			Direction – Cnt 1	
%Q1606			Output Reset – Counter 1	
%Q1607			Preload Disable – Counter 1	
%Q1608			Latch Disable – Counter 1	
%Q1609				Disable Marker – C1
%Q1610				Latch Marker – C1
%Q1611				Preload Marker – C1
%Q1612				Clear Marker – C1
%Q1613-1616			Reserved	
%Q1617			Latch – Counter 2	
%Q1618			Preload – Counter 2	
%Q1619			Clear – Counter 2	
%Q1620			Disable – Counter 2	
%Q1621			Direction – C2	
%Q1622			Output Reset – Counter 2	
%Q1623			Preload Disable – Counter 2	
%Q1624			Latch Disable – Counter 2	
%Q1625				Disable Marker – C2
%Q1626				Latch Marker – C2
%Q1627				Preload Marker – C2
%Q1628				Clear Marker – C2
%I1601			Overflow Flag – Counter 1	
%I1602			Underflow Flag – Counter 1	
%I1603			High Speed Out 1	
%I1604			Reserved	
%I1605			Overflow Flag – Counter 2	
%I1606			Underflow Flag – Counter 2	
%I1607			High Speed Out 2	
%I1608			Reserved	

11.4 High Speed Output Functions

On units that support the PWM, two dedicated outputs are available that can be configured for one of four modes of operation. Those modes are Normal, PWM, HSC Match and Stepper.

11.4.1 Normal

When either Q1 or Q2 is configured for Normal operation, the digital output registers %Q1 and %Q2 drives that respective output.

11.4.2 PWM

When either Q1 or Q2 is configured for PWM, the PWM function drives that respective output. Both PWM channels may be individually enabled and can have independent frequency and duty cycles.

The PWMs require two parameters (%AQs) to be set for operation. These parameters may be set at run-time.

- **Duty Cycle**
The Duty Cycle is a 32 bit value from 0 to 32,000 indicating the relative duty cycle of the output. For example a value of 8000 would indicate a 25% duty cycle, a value of 16,000 would indicate a 50% duty cycle. 0 turns the output off, 32,000 turns the output on.
- **Frequency**
The Frequency is a 32 bit value indicating the output frequency in Hertz. One over the frequency is the period.

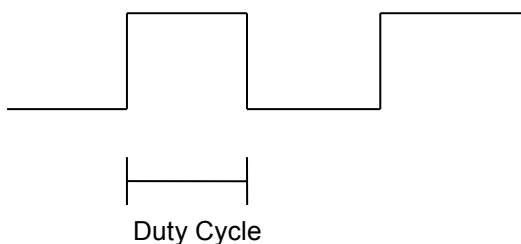
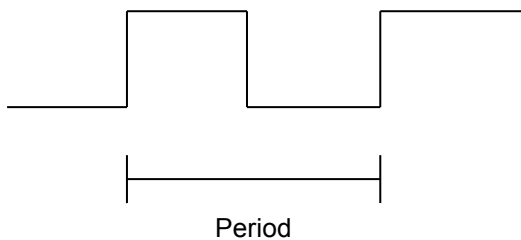

At controller power-up or during a download, the PWM output is maintained at zero until both the Frequency and the Duty cycle are loaded with non-zero values. When the controller is placed in stop mode, the state of the PWM outputs is dependent on the *PWM State on Controller Stop* configuration. This configuration allows for either hold-last-state or specific frequency and duty cycle counts. Specifying zero for either the period or duty causes the PWM output to remain low during stop mode.

Note for standard I/O modules (1E3, 1E4 and 1E5 models) that the nominal output driver turn-on-time delay (to reach 50% output) is 25 microseconds. Therefore, this limitation should be considered when determining both the minimum pulse width and the duty cycle accuracy of the application. Special high speed output options will be available.

11.4.3 HSC Output (High Speed Counter Match)

When either Q1 or Q2 is configured for HSC Output operation, HSC1 or HSC2 turns on, off or toggles based on a comparison between the counter accumulator and match registers. See details above in the high speed input section.

11.4.4 Stepper Function

The XL4 supports two stepper functions, one on each high speed output.

The Stepper requires five parameters (%AQs) to be set for operation. These parameters may be set at run-time but are 'latched' when the stepper is commanded to start.

Start Frequency (cycles per second)

This value sets the frequency for the first cycle during the acceleration phase and the frequency of the last cycle during the deceleration phase. When an acceleration or deceleration count is specified, the Start Frequency must be greater than 0 and must not exceed the run frequency or an error is generated.

Run Frequency (cycles per second)

This value sets the frequency for the last cycle during the acceleration phase, the consistent frequency during the run phase, and the frequency of the first cycle during the deceleration mode. The Run Frequency must be greater than 0 and must not exceed 5000 cycles/sec. or an error is generated.

Acceleration Count

This value sets the number of cycles to occur within the acceleration phase. The frequency of the cycles within this mode will vary linearly between the specified Start and Run frequency. The Accel count must not equal 1 or an error is generated. Setting this value to zero disables this phase.

Run Count

This value sets the number of cycles to occur within the run phase. The frequency of the cycles within this mode is constant at the specified Run frequency. The Run count may be any value. Setting this value to zero disables this phase.

Deceleration Count

This value sets the number of cycles to occur within the deceleration phase. The frequency of the cycles within this phase will vary linearly between the specified Run and Stop frequency. The Decel count must not equal 1 or an error is generated. Setting this value to zero disables this phase.

The stepper provides two Boolean registers to provide stepper status

Ready/Done

A high indication on this register indicates the stepper sequence can be started (i.e. not currently busy).

Error

A high indication on this register indicates that one of the analog parameters specified above is invalid or the stepper action was aborted before the operation was complete. This register is cleared on the next start command if the error was corrected.

The stepper requires one discrete register to control the stepper action. Setting this register starts the stepper cycle. This register must remain set to complete the entire cycle. Clearing this register before the cycle is complete aborts the step sequence and sets the error bit.

Note that setting the PLC mode to Stop while the stepper is in operation causes the stepper output to immediately drop to zero and the current stepper count to be lost.

Note that stepper output level may cause damage or be incompatible with some motor driver inputs. Consult drive documentation to determine if output level and type is compatible.

11.5 PWM functions register map

The register assignments for the high speed I/O can be moved via a setting in Cscape. The values shown are the DEFAULT values and may not match the same starting point as the values shown below.

Register	PWM	Stepper
%AQ421-422	PWM 1 Duty Cycle (32-bit)	Start Frequency – Stepper 1
%AQ423-424	PWM 1 Frequency	Run Frequency – Stepper 1
%AQ425-426		Acceleration Count – Stepper 1
%AQ427-428		Run Count – Stepper 1
%AQ429-430		Deceleration Count – Stepper 1
%AQ431-432	PWM 2 Duty Cycle (32-bit)	Start Frequency – Stepper 2
%AQ433-434	PWM 2 Frequency	Run Frequency – Stepper 2
%AQ435-436		Acceleration Count – Stepper 2
%AQ437-438		Run Count – Stepper 2
%AQ439-440		Deceleration Count – Stepper 2
%Q1		Digital Out – Stepper 1
%Q2		Digital Out – Stepper 2
%I1617		Ready/Done – Stepper 1
%I1618		Error – Stepper 1
%I1619		Ready/Done – Stepper 2
%I1620		Error – Stepper 2

11.6 PWM Examples

Example 1

To get a 50% Duty Cycle @ 10 kHz waveform on PWM1:

Set %AQ421-422 = 16,000 (duty cycle)

Set %AQ423-424 = 10,000 (frequency)

Example 2

To get a 50% Duty Cycle on PW1 and 90 % Duty Cycle on PWM2 @ 1 kHz waveform:

Set %AQ421-422 = 16,000 (duty cycle)

Set %AQ423-424 = 1,000 (frequency)

Set %AQ431-432 = 28,800 (duty cycle (32000 * 0.9))

Set %AQ433-434 = 1,000 (frequency)

Example 3

To turn PWM 1 output ON all the time

Set %AQ421-422 = 32,000 (duty cycle)

Set %AQ423-424 = Any Value (frequency)

Example 4

To turn PWM 1 output OFF all the time

Set %AQ421-422 = 0 (duty cycle)

Set %AQ423-424 = Any Value (frequency)

11.7 STP Examples

Example 1

10,000,000 steps control sequence

The following example starts at 2.5 kHz and ramps up to 5 kHz during the first 1,000,000 steps. Then, it runs at 5 kHz for the next 8,000,000 steps. Finally during the last 1,000,000 steps it slows to a stop.

Set %AQ1 = 2500 (Hz)	{Start Frequency}
Set %AQ2 = 5000 (Hz)	{Run Frequency}
Set %AQ3-4 = 1000000 (Steps)	{Accel Count}
Set %AQ5-6 = 8000000 (Steps)	{Run Count}
Set %AQ7-8 = 1000000 (Steps)	{Decel Count}

Example 2

5,000,000 steps control sequence

The following example starts at 0.5 kHz and ramps up to 1 kHz during the first 2,000,000 steps. Then, it runs at 1 kHz for the next 2,000,000 steps. Finally during the last 1,000,000 steps it slows to a stop.

Set %AQ1 = 500 (Hz)	{Start Frequency}
Set %AQ2 = 1000 (Hz)	{Run Frequency}
Set %AQ3-4 = 2000000 (Steps)	{Accel Count}
Set %AQ5-6 = 2000000 (Steps)	{Run Count}
Set %AQ7-8 = 1000000 (Steps)	{Decel Count}

Example 3

6,000,000 steps control sequence

The following example starts at 50 Hz and ramps up to 250 Hz during the first 150,000 steps. Then, it runs at 250 Hz for the next 5,500,000 steps. Finally during the last 350,000 steps it slows to a stop.

Set %AQ1 = 50 (Hz)	{Start Frequency}
Set %AQ2 = 250 (Hz)	{Run Frequency}
Set %AQ3-4 = 150000 (Steps)	{Accel Count}
Set %AQ5-6 = 5500000 (Steps)	{Run Count}
Set %AQ7-8 = 350000 (Steps)	{Decel Count}

CHAPTER 12: SYSTEM SETTINGS AND ADJUSTMENTS

12.1 System Menu - Overview



The XL4 has a built-in System Menu, which lets the user view System Settings and makes adjustments. To start the System Menu, press the SYSTEM key (or set %SR3 to 1), which will display the Main Menu. Then use the ↓ and ↑ (Up Arrow or Down Arrow) keys to select a **Main Menu** item and press **Enter** (Return Arrow) to display the item's Sub-Menu.

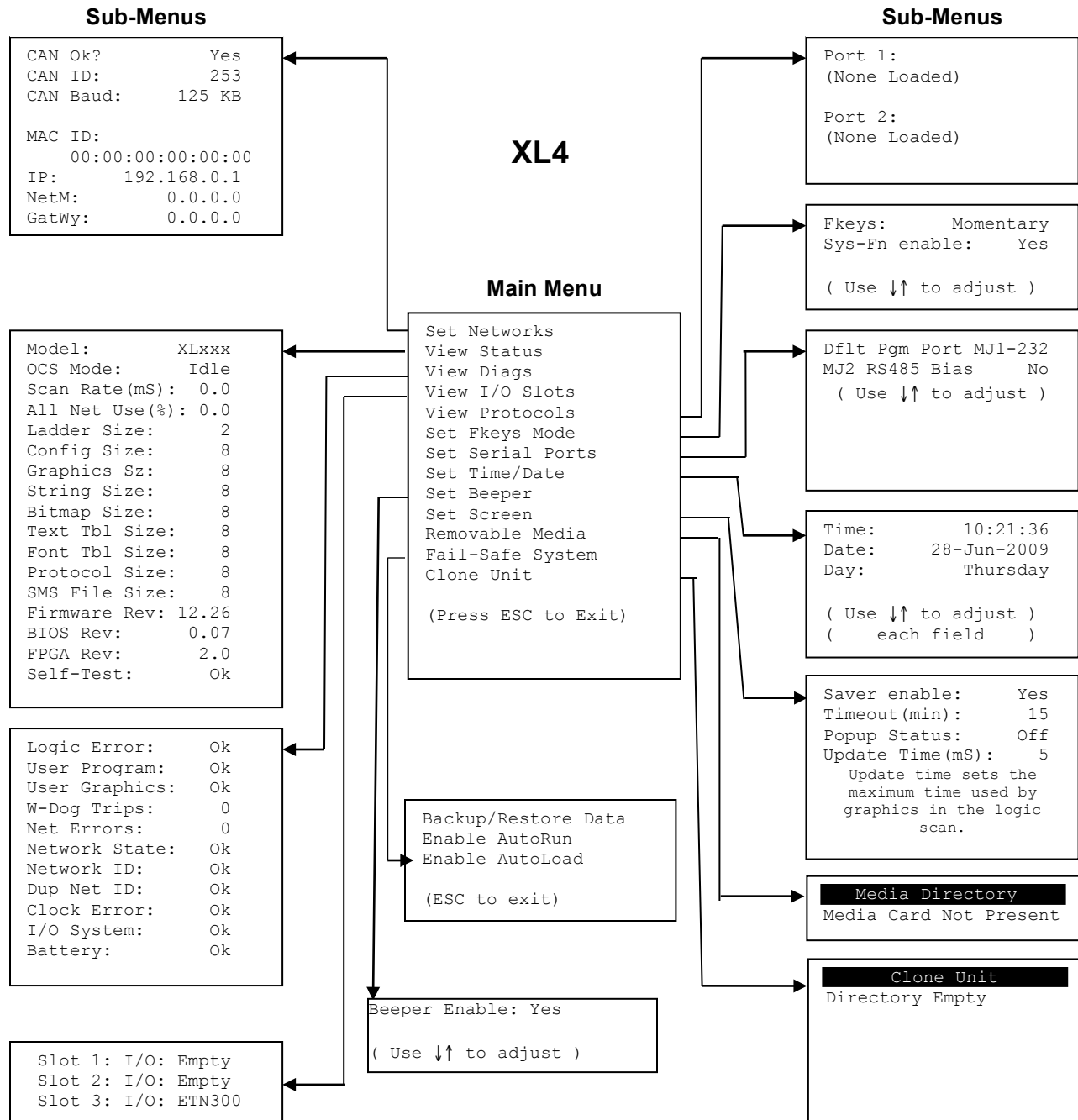

Figure 12.1 – System Menu

F

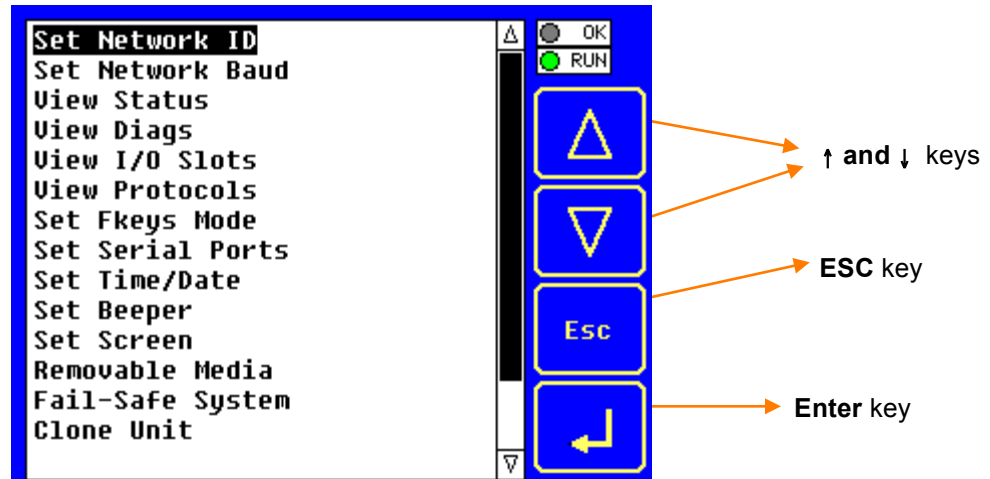



Figure 12.2 – System Menu (XL4) Screenshot

12.2 System Menu – Navigation and Editing

As mentioned above, the System Menu is started by pressing the System key on the XL4. Next press **ESC** to exit the System Menu, or use **↓ and ↑** to select an item and press **Enter**  to display the item's Sub-Menu.

A Sub-Menu generally shows a list of System Settings and their values. After opening a Sub-Menu, if any of its System Settings are editable, the first System Setting that can be edited is highlighted. If desired, the **↓ and ↑** keys can be used to select a different System Setting to be edited.

At this point, either press **ESC** to exit the Sub-Menu (returning to the Main Menu) or press **Enter** to edit the highlighted System Setting. If **Enter** is pressed, the System Setting's value will be highlighted, indicating that it is ready to be modified.

When modifying a System Setting's value, use either the arrow keys (**← → ↓**)  or the numeric keys, or the appropriate touch screen icons to select a new value.

The arrow keys are used to edit System Settings that have just a few possible values. Each time the arrow key is pressed, a new possible value is displayed. When the desired value appears, press the **Enter** key to save it; otherwise press the **ESC** key to cancel the edit.

The numeric keys are normally used to enter numeric System Settings.

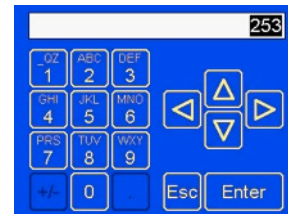

In addition, to edit a single numeric digit, use the **←** or **→** key to select the digit and then either press a numeric key or use **↓** or **↑** to modify the digit. In any case, after entering the new desired value, press the **Enter** key to save it; otherwise press the **ESC** key to cancel the edit.

12.3 System Menu – Details

The following sections describe each of the Sub-Menus in detail.

Set Networks

This sub menu allows setting for the CAN and Ethernet network to be viewed or changed.

CAN Ok?	Yes	= CAN1 connected to a CAN network and functioning properly
	No	= Not ready to communicate on CAN network
CAN ID:	1 to 253	= This node's CsCAN Network ID; must be unique on network
CAN Baud?	125 KB	= 125 Kbaud CAN network
	250 KB	= 250 Kbaud CAN network
	500 KB	= 500 Kbaud CAN network
	1 MB	= 1 Mbaud CAN network
MAC ID:		Displays the Ethernet MAC ID of the unit
IP:		Displays the Ethernet IP address of the unit
NetM:		Displays the Ethernet net mask of the unit
GatWy:		Displays the Ethernet gateway of the unit

Note: The IP address, Net Mask and Gateway can be changed from the system menu. This is designed for commissioning or temporary field changes. The actual parameters are defined in Cscape under the Ethernet configuration.

View Status

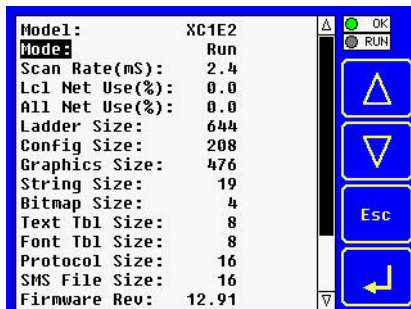

The View Status Sub-Menu displays up to 19 System Settings. Only the **Mode** System Setting is editable.

Model:	XL1yz	= Model number of this XL4 OCS unit 1yz indicates the installed I/O module; 00 = no I/O module
OCS Mode:	Idle	= XL4 OCS is in Idle mode
	DoIO	= XL4 OCS is in Do I/O mode
	Run	= XL4 OCS is in Run mode
Scan Rate(mS):	0.0	= XL4 OCS is not in Run mode
	0.1 to 999.9	= Average number of mS for each ladder scan

OCS Net Use %:	0.0 to 100.0	= CAN network bandwidth % used by this XL4 OCS node
All Net Use %:	0.0 to 100.0	= CAN network bandwidth % used by all nodes
Ladder Size:	x	= Number of bytes in application ladder program
Config Size:	x	= Number of bytes in application I/O configuration
Graphics Size:	x	= Number of bytes in application graphic screens
String Size:	x	= Number of bytes in application string table
Bitmap Size:	x	= Number of bytes in application bitmaps
Text Tbl Size:	x	= Number of bytes in application text tables
Font Tbl Size:	x	= Number of bytes in application font tables
Protocol Size:	x	= Number of bytes in application downloaded protocols
SMS File Size:	x	= Number of bytes in application SMS protocol configuration
Firmware Rev:	xx.yy	= Current firmware version
OS Ver:	a.b.cd.yz	= Current Operating System version
FPGA Rev:	x.y	= Current FPGA version (High Speed IO Sub System)
InitRD Rev:	x.yz	= Bootloader version
Self-Test:	Ok	= All power-on self-tests passed
	Fault	= One or more power-on self-tests failed

View Diags

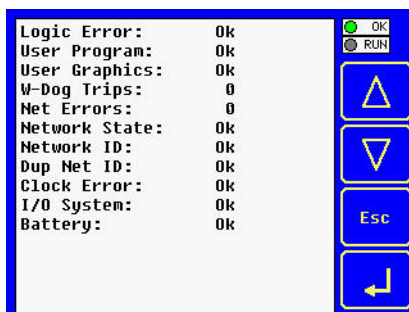

The View Diags Sub-Menu displays up to 11 System Diagnostics, none of which are editable.

The first two System Diagnostics are critical. If any of them indicate a Fault condition, the XL4 OCS will not enter or remain in Run mode, and the problem must be investigated and corrected.

Logic Error:	Ok	= All executed ladder instructions are legal for loaded firmware
	Fault	= A ladder instruction <u>not</u> supported by firmware was found

User Program: Ok = Ladder program and I/O configuration loaded successfully
 Fault = Ladder program or I/O configuration not loaded or load failed

The last nine System Diagnostics are informational. If any of them indicate a Warning condition, the XL4 OCS can still enter and remain in Run mode, but the problem should be investigated and corrected.

User Graphics: Ok = Application graphics objects loaded successfully
 Fault = Application graphics objects not loaded or load failed

W-Dog Trips: 0 = Watchdog timer has not tripped since the last power-up
 x = Number of times watchdog timer has tripped

Net Errors: 0 = No CAN network bus-off errors have occurred
 x = Number of CAN network bus-off errors that have occurred

Network State: Ok = At least one other node was found on the CAN network
 Warning = No other nodes were found on the CAN network

Network ID: Ok = This node's CAN Network ID is in the range 1 to 253
 Warning = This node's CAN Network ID was out of range at power-up

Dup Net ID: Ok = This node's Network ID is unique on the CAN network
 Warning = This node's Network ID is duplicated in another node

Clock Error: Ok = Time and date have been set
 Warning = Time and date need to be set

I/O System: Ok = I/O configuration matches the installed I/O and COM modules
 Warning = I/O configuration needs updating to match installed modules

Battery: Ok = Backup battery operating properly
 Warning = Backup battery needs to be replaced

View I/O Slots



The View I/O Slots Sub-Menu displays three System Settings, all of which are not editable.

Internal to the XL4 OCS, there is a CPU board, and up to two installed modules. Model XE100 has no installed I/O or COM modules. All other models have an I/O module and can have a user-installed COM module.

Depending on which I/O module is installed and which I/O module has been configured by Cscope, one of the following six System Settings should appear for Slot 1:

Slot 1: I/O: Empty	= No I/O module installed or configured
Slot 1: *Unsupported	= Unsupported I/O module installed
Slot 1: -I/O Missing	= No I/O module installed but an I/O module is configured
Slot 1: +I/O: XExyy	= yy I/O module installed but no I/O module configured
Slot 1: ?I/O: XExyy	= yy I/O module installed but another I/O module configured
Slot 1: I/O: XExyy	= yy I/O module installed and configured properly

Depending on the COM module that is installed and the COM module that has been configured by Cscape, one of the following six System Settings appears for Slot 2:

Slot 2: I/O: Empty	= No COM module installed or configured
Slot 2: *Unsupported	= Unsupported COM module installed
Slot 2: -I/O Missing	= No COM module installed but a COM module is configured
Slot 2: +I/O: XzC	= z COM module installed but no COM module configured
Slot 2: ?I/O: XzC	= z COM module installed but another COM module configured
Slot 2: I/O: XzC	= z COM module installed and configured properly

Slot 3: I/O: **ETN300** = ETN300 has been configured through Cscape.

View Protocols

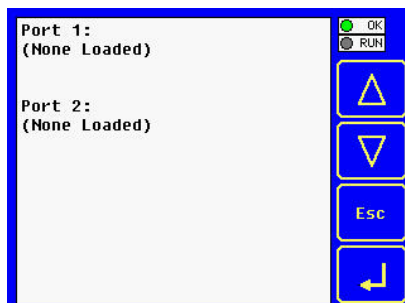

The View Protocols Sub-Menu displays two System Settings, neither of which are editable.

As mentioned in 0, both the MJ1 (Port 1) and MJ2 (Port 2) serial ports support downloadable protocols. To assign a downloadable protocol to an XL4 OCS serial port, select the **Protocol Config** item in Cscape's Program menu and then setup a protocol for Port 1 or Port 2 (or both).

In the View Protocols Sub-Menu, the currently downloaded protocol, if any, and its version number are displayed for both Port 1 and Port 2.

Port 1:	
Protocol name	= (None Loaded) or name of the protocol assigned to MJ1
Protocol version	= Blank or version of the protocol assigned to MJ1

Port 2:

Protocol name
Protocol version

= **(None Loaded)** or name of the protocol assigned to MJ2
= Blank or version of the protocol assigned to MJ2

Set Fkeys Mode

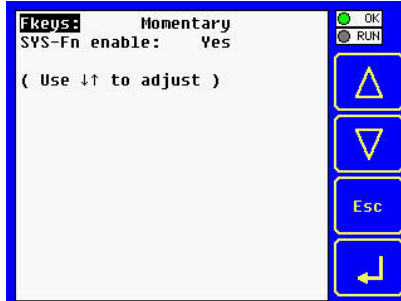

The Set Fkeys Sub-Menu displays two System Settings, both of which are editable.

- Fkeys:**
 - Momentary = %K1-4 bits go On & Off as F1-F4 are pressed & released
 - Toggle = %K1-4 bits toggle each time F1-F4 are pressed
- SYS_Fn enable:**
 - Yes = Reset and all clear system functions enabled
 - No = Reset and all clear system functions disabled

Set Serial Ports

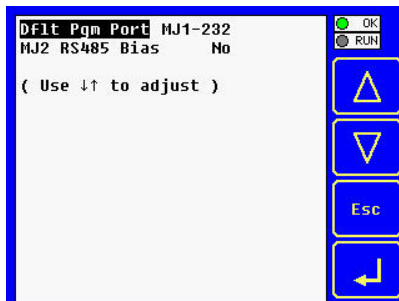

The Set Serial Ports Sub-Menu displays three System Settings, all of which are editable, and one optional item. For the **Dflt Pgm Port** System setting, only MJ1-232 can be selected, unless a Modem (XMC) COM module is installed.

- Dflt Pgm Port:**
 - MJ1-232 = MJ1 RS232 port is the default programming port
 - Modem = Modem COM module is the default programming port
- MJ2 RS485 Bias:**
 - No = MJ2 RS485 bias resistors are not switched in
 - Yes = MJ2 RS485 bias resistors are switched in

Set Time/Date

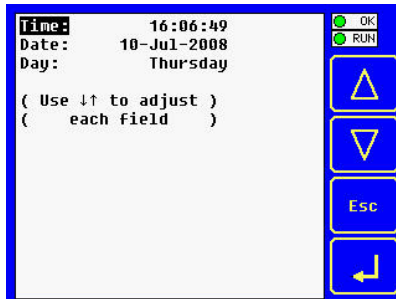

The Set Time/Date Sub-Menu displays three System Settings. **Time** and **Date** are editable, and **Day** is automatically calculated from the **Date** setting. Note that **Time** and **Date** are split into three editable fields each. Use ← or → to select a field and then use ↓ or ↑ to edit the field.

Time:	16:09:49	= Current time (hours:minutes:seconds in 24-hour format)
Date:	10-Jul-2008	= Current date (day-month-year)
Day:	Thursday	= Current day of week calculated from the Date setting

Set Beeper

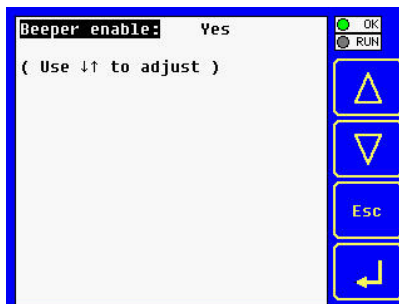

The Set Beeper Sub-Menu displays one System Setting, which is editable

Beeper enable: Yes (default)= Enables beeper No = Disables beeper (does NOT affect ladder access)

Set Screen

The Set Screen Sub-Menu displays four System Settings, all of which are editable

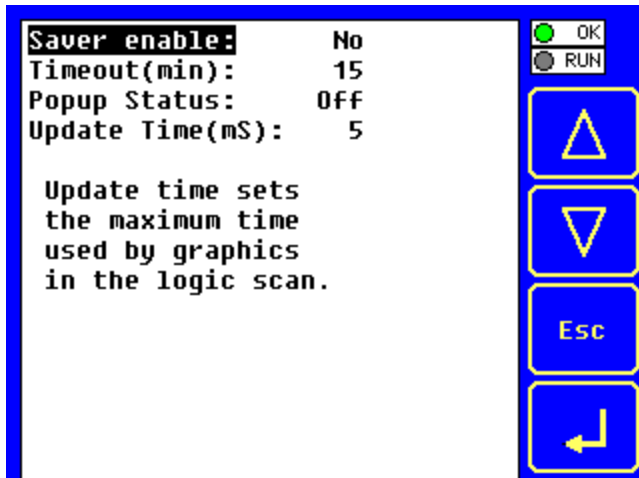

Saver enable: Yes = Enable screen saver
 No (default) = Disable screen saver

Timeout (min): 5 - 1200 = Amount of time in minutes to expire with NO touch activity before activating screen saver (black screen)

Popup Status: Off (default) = Disable popup status
 Warning = Display popup status only if controller status changes to NOT Ok or NOT Run mode.

ON = Display popup status on any controller status change.

Update Time (mS): 2 - 50 = Maximum amount of time to allow for graphics update per scan

Removable Media

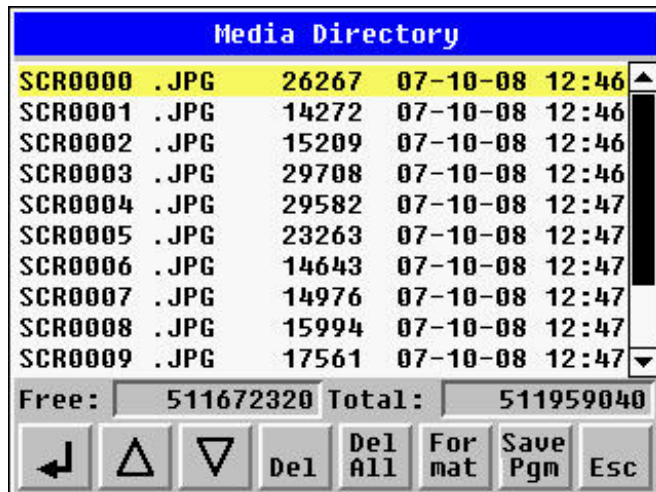

The Removable Media Sub-Menu displays the Removable Media Manager. After selecting Removable Media from the Main Menu, one of four Sub-Menu screens will appear:



= No Micro SD card has been installed in the Memory slot



= Micro SD card is installed, but it is still initializing

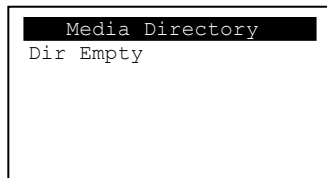

= Micro SD card is installed and initialized, but contains no files

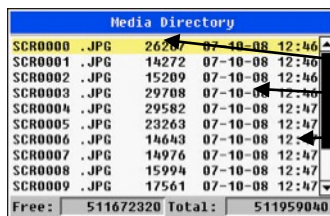

= Micro SD card is installed and initialized, and it contains files

Shows size of highlighted file or shows <DIR> if directory is highlighted

Shows the date file or directory was created or last modified

Shows the time file or directory was created or last modified

Scrollbar.

If a directory name is highlighted, pressing **Enter** will switch to that directory showing its files and sub-directories. In a sub-directory, highlighting .. (dot dot) and pressing **Enter** will move up one directory.

Fail – Safe System

The Fail-Safe System is a set of features that allow an application to continue running in the event of certain types of "soft" failures. These "soft" failures include:

- Battery power loss
- Battery-Backed Register RAM or Application Flash corruption due to, for example, an excessive EMI event.

Selecting "Fail-Safe System" menu will open the following menu screen:

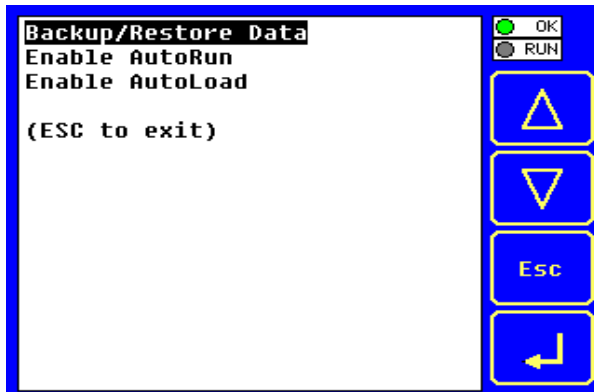

Selecting Backup/Restore Data displays the following screen in:



- Backup = Copies Battery Backed RAM contents on to the onboard FLASH memory of the OCS.
- Restore = Copies the backed up data from onboard FLASH to the battery backed RAM.
- Clear Backup = The backup data will be erased from the onboard FLASH.
- Exit = Goes back to previous menu.

“Enable AutoRun” displays the following options which can be selected:

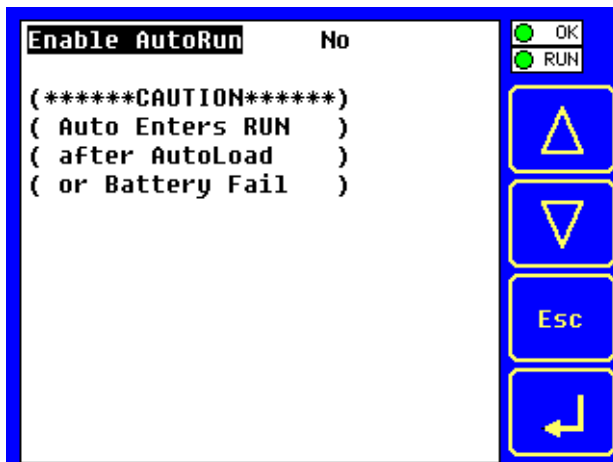

Enable AutoRun No = OCS will be in IDLE mode after AutoLoad or Automatic Restore.
 Yes = OCS will be automatically placed into RUN mode after AutoLoad or Automatic Restore.

“Enable AutoLoad” displays the following options which can be selected:

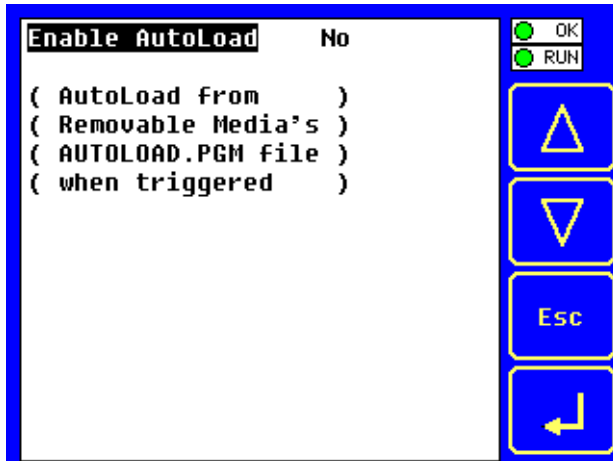

Enable AutoLoad No = Does not load AUTOLOAD.PGM automatically when application program is absent or corrupted.
 Yes = Loads AUTOLOAD.PGM file automatically from RM when application program is absent or corrupted.

Clone Unit

‘Clone Unit’ feature allows the user to “clone” the OCS of the exact same model. This feature “clones” application program and unit settings stored in Battery backed RAM of an OCS into the RM (refer Removable Media [Chapter 9](#) for details on using RM). It can then be used to clone a different OCS (exact same model).

This feature can be used for:

- Replacing an OCS by another unit of the same model.
- Duplicating or “clone” units without a PC.

Clone

Selecting “Clone Unit” menu will open the following menu screen:

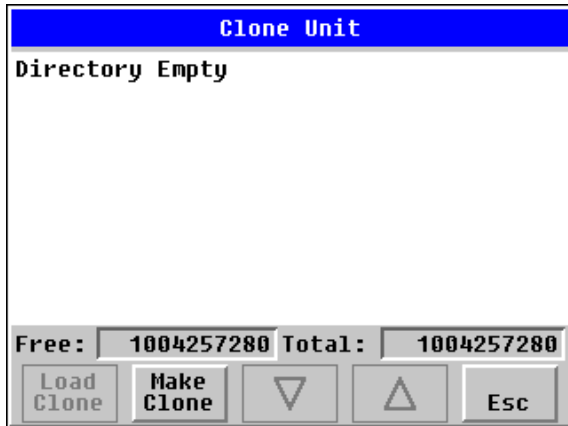

Note:

Free/Total – displays number of free and total bytes in Removable Media.

Selecting Make Clone brings up the screen below for the user:

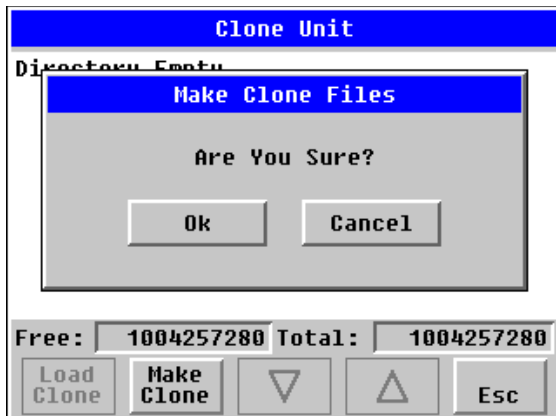

After confirmation, the OCS will create two new files in the root directory of the Removable Media Drive as shown below:

- AUTOLOAD.PGM** Application file
- CLONE.DAT** File having all unit settings and register values from Battery Backed RAM

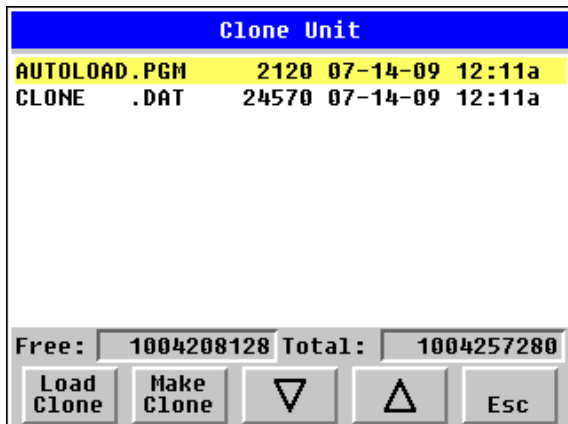

Load Clone

Selecting “Clone Unit” menu will open the following menu screen. Select “Load Clone”.

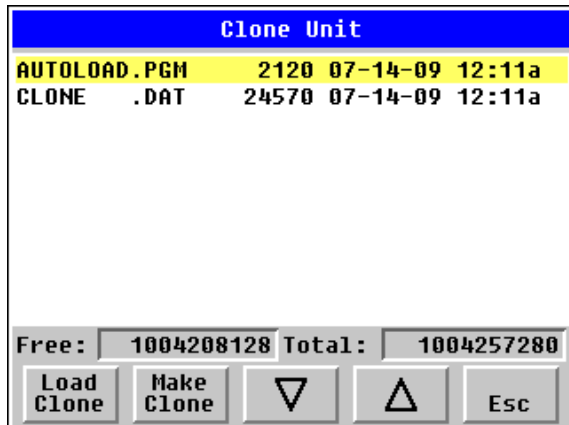

NOTE: For security enabled files, Load clone asks for password validation before loading the application.

12.4 Touch screen calibration

The touch screen is calibrated at the factory and rarely needs modification. However, if actual touch locations do not appear to correspond with responding objects on the display, field adjustment is available. To access the field adjustable touch screen calibration dialog, press and hold both the SYS and F1 key for longer than 2 seconds and a dialog similar to figure 9.2 should appear. Thereafter, use a plastic tip stylus and follow the dialog instructions.

Note that special system keys may be locked out from user access. If the SYS-F1 combination does NOT respond, verify that the system menu’s Set Fkeys sub-menu’s parameter SYS_Fn is enabled.

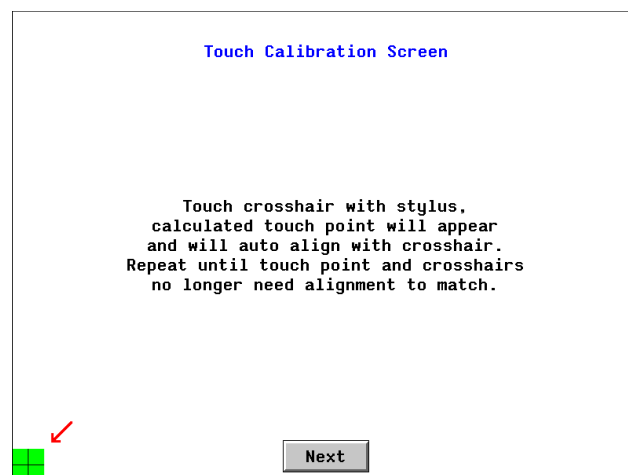

CHAPTER 13: USER INTERFACE

13.1 Overview

This chapter presents the user interface (or operator view) of the XL4 and some of the model specific characteristics of the XL4 as compared to the rest of the OCS line. This chapter does NOT cover building screens or using the CSCAPE graphics editor. For instructions on creating screens and using the graphics editor, refer to the graphics editor help file.

The following aspects are discussed:

- Displaying and entering data
- Alpha-numeric data entry
- Navigating around screens
- Beeper acknowledgement
- Touch (slip) sensitivity
- Alarm log dialog
- RM dialog
- Screen Saver
- Dimmer

13.2 Displaying and entering Data

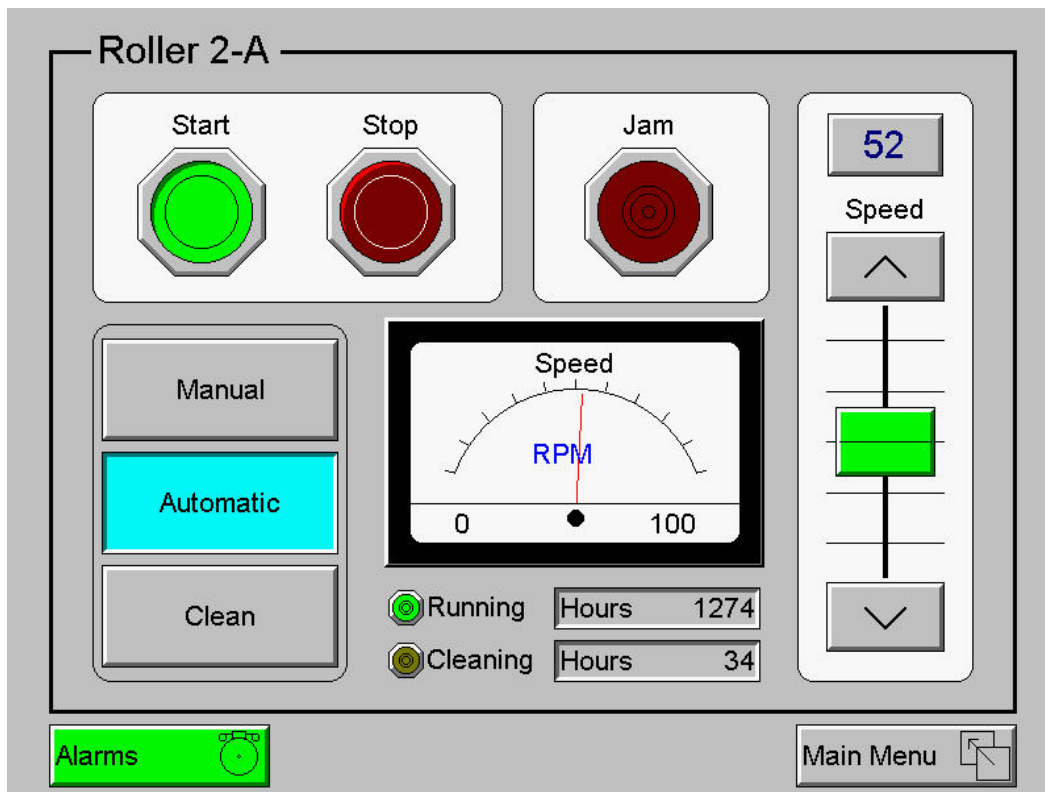

Figure 13.1 – Example Screen (XL4 only)

Multiple objects are provided for displaying data such as virtual panel lights, push buttons, numeric value displays, bar graphs, meters, graphs and animated bitmaps. On the XL4, these graphical objects (through ladder manipulation of attribute bits) can change color, flash or change visibility to attract operator attention.

On objects that accept user input, the input is provided by touching the object or alternately changing an OCS register (i.e. Function key registers). Objects that allow input generally have a raised 3D appearance. An exception is the binary type objects, such as buttons, which are shown in a depressed 3D appearance when in the ON state. Objects that normally accept touch input may be disabled through program control (through ladder manipulation of an attribute bit). If an object is disabled, the object's representation changes to a 2D appearance.

On objects that represent non-discrete information, more action may be required beyond that of simply touching the object. For example, the slider object requires the operator to touch and *slide* the control in the direction desired. Alternately, alpha-numeric entry objects invoke a pop-up alpha-numeric keypad for additional user input. The alpha-numeric keypad is discussed below.

Note that if the numeric entry object displays >>>>>>, the value is too big to display in the field or is above the maximum for an editable field. Likewise, if the numeric entry object displays <<<<<< in a numeric field, the value is too small to display or is below the minimum for an editable field.

13.3 Alpha-numeric keypad

To allow entry of a specific number or text, several of the input objects invoke a pop-up alpha-numeric keypad when the object is touched. An example of the alpha-numeric keypad invoked from a numeric input object is shown in Figure 13.2. Once invoked, the operator may touch the appropriate keys to enter a specific value. When entering a value, the alpha-numeric keypad is in one of two modes [new-value or edit-value].

New-value mode

Generally, when the alpha-numeric keypad is first invoked, it is placed in new-value mode. Initially, the alpha-numeric keypad displays the current value with all the digits being highlighted. Once the first digit is entered, the current value is erased from the display and the new digit is placed in the first location. Thereafter, no digits are highlighted and new digits are added to the rightmost position while the other digits are shifted left.

Edit-value mode

Edit-value mode may be entered from the initial new-value mode by pressing either the left or right arrow key before any digit key is pressed. The result will be a single character highlighted. The user may then either touch a key to change the digit at the selected position or the up and down arrows may be used to add or subtract (respectively) from the selected digit. The user may then use the left or right arrow keys to select a new position.

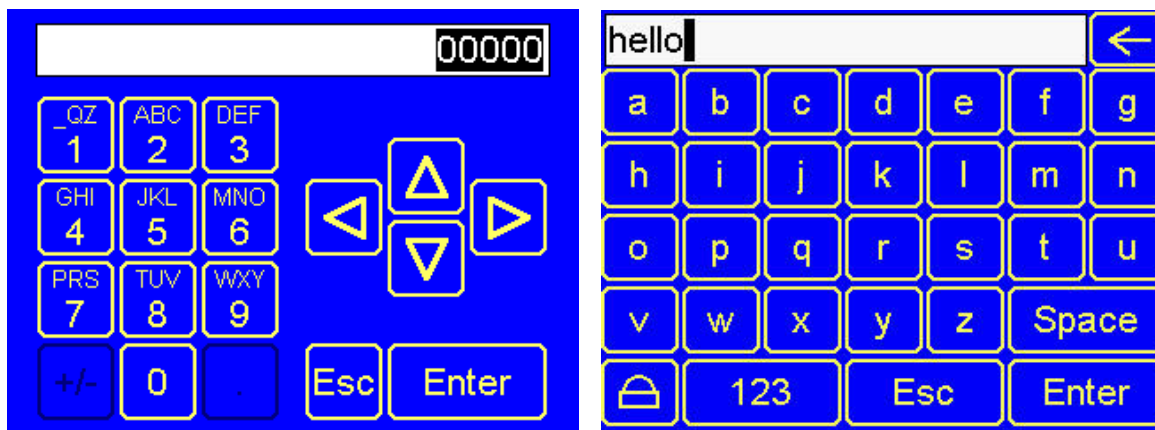

Figure 13.2 – Alpha-numeric Keypad and ASCII Keypad

Once the desired value is entered, pressing the *Enter* key moves that value into the object (and the corresponding OCS register) and the alpha-numeric keypad disappears. Alternately, pressing the *ESC* key any time before the *Enter* key cancels the operation, leaves the objects current value unchanged, and the alpha-numeric keypad disappears.

Note: Each numeric entry object has a configured minimum and maximum value. If the operator enters a value outside of the configured range, the new value is ignored when *Enter* is pressed and the current object value is NOT changed.

Since the alpha-numeric keypad services several different graphical objects, certain keys on the alpha-numeric keypad may be disabled (grayed) when the keypad is invoked for certain objects. The following describes the alpha-numeric keypad variation based on object.

Numeric Object

When editing a numeric value, the [+/-] or the [.] key are disabled (grayed) if the object is NOT configured for floating-point value or a signed value.

Password Object

When editing a password value, the arrow keys, [+/-], and the [.] keys are disabled. Additionally, overwrite mode is disabled. When entering digits, the pop-up keypad hides the value by displaying '*' alternately for each digit.

ASCII Object

When editing an ASCII value, an ASCII keypad is displayed as shown figure 13.2. The ASCII keypad has 3 modes, numeric, symbols and alpha. In Alpha mode the Caps Lock button may be pressed to access capitol letters. When you first enter this editor typing a character will overwrite the entire old string and start a new entry. You may press the back space arrow to delete the previous character. Pressing Enter will save the entry, pressing ESC will cancel the edit and return the string to the previous value.

Text Table Object

When editing a Text Table Object, all the keys except the Up and Down arrow keys are grayed and disabled. The next text selection is made by pressing either the Up or Down arrow.

Time/Date Object

When editing a Time/Date Table Object, all the keys except the Up, Down, Left and Right arrow keys are grayed and disabled. The specific field (i.e. hour or minutes) is selected using the Left and Right arrows. The value in the selected field is changed by pressing either the Up or Down arrow.

13.4 Screen Navigation

To allow the operator to change screens, a **screen jump object** is generally used. This object may be visually **represented as a 3-D button** (responding to touch) or remain invisible and logically tied to an OCS register. An optional system ICON may be configured for display along with the legend, which aids in identifying the object as one that causes a screen change (shown below in figure 13.3)

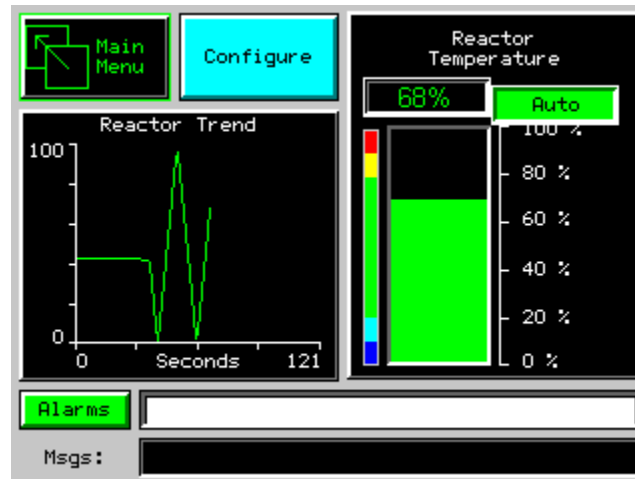

Figure 13.3 – Typical Screen Jump Object (XL4)

Screen jumps can also be triggered on other keys or based on control logic for more advanced applications. To allow the operator to change screens, a **screen jump object** is generally used. This object may be visually **represented as a button** (responding to touch) or remain invisible and logically tied to an OCS register. An optional system ICON may be configured for display along with the legend, which aids in identifying the object as one that causes a screen change.

13.5 Ladder Based Screen Navigation

Ladder logic can use several techniques to control screen navigation. Coils can be tied to %D registers to make them screen coils. These coils have two modes, switch and alarm. If the ladder program energizes an alarm display coil, the screen associated with this coil is displayed and overrides the normal user screens. This is designed to show alarm conditions or to display other ladder-detected events. When the text coil is de-energized, the previous screen that was being viewed before the alarm is returned.

The switch display coil switches to the associated screen when it is energized. Once it is de-energized the screen remains until it is switched by the user or ladder.

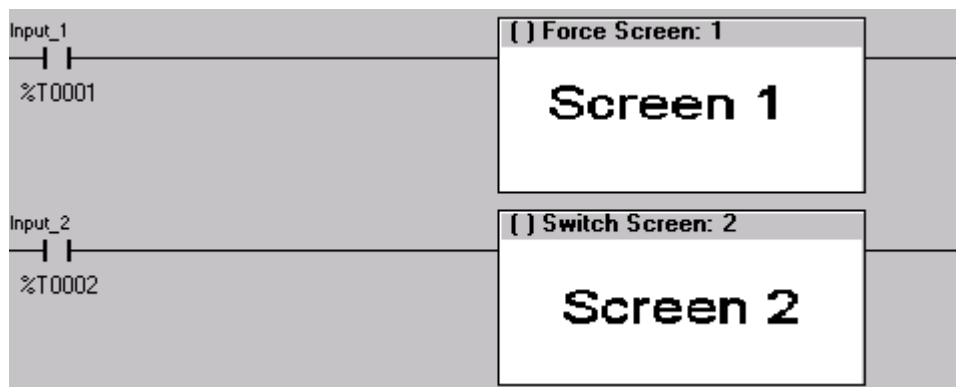

Figure 13.4 – Force and Switch Coils in Ladder Programming

There is also a system register that can be used for control based screen navigation. %SR1 can be read to determine the current screen or written to change the current screen.

Refer to the on-line help in Cscape for more information on control-based screen navigation.

13.6 Beeper Acknowledgement

The XL4 contains an internal beeper that provides an audible acknowledgment when an operator touches a graphic object that accepts touch input. When the graphic object is enabled, a short 5ms tone is emitted. When the graphic object is disabled, a longer 100ms tone is emitted to enounce that graphical object is not currently accepting the touch input.

If beep acknowledgement is not desired, the beeper function can be disabled from the system menu.

13.7 Touch (Slip) Sensitivity

Touch *slip* sensitivity is preset to meet most applications; however, adjustment is available to reduce the sensitivity for touch release. That is, once a graphical object (button) is touched and held by a finger, the default touch *slip* sensitivity allows for a slight *slip* of the finger on the graphical object before the XL4 assumes touch been released (equates to approximately a quarter inch of movement with a stylus).

In some applications (such as jog buttons) where the operator is pushing a button for a period of time, the amount of *slip* while holding a button pressed may exceed the default sensitivity. To increase the amount of tolerable *slip* and prevent false releases of the button, the XL4 allows adjustment of the allowable *slide* up to 5x the default value.

To enable the touch (slip) sensitivity, first an OCS data register must be allocated through the Graphics editor Configuration menu for Display Settings. Once a Touch Sensitivity register is assigned, that register may be modified [range = 1(Low) to 5 (High)] to the desired slide amount. If a value outside the valid range is entered in the touch sensitivity register, it is ignored and the last valid value is used.

13.8 Alarms

Alarm presentation to the operator is highly configurable and beyond the scope of this document to describe fully. For more information refer to the graphics editor help file. This section presents a typical configuration thereby providing an introductory description on what the operator should expect.

The alarm object is generally used to enunciate alarms to the operator. While the display characteristics of this object is configurable, it is generally displayed as a button that changes colors to indicate the highest state of the alarm(s) in the alarm group it is monitoring. The following indicates the priority of the alarm states and the default colors associated with these states.

- Highest (Red) - Unacknowledged Alarms Exist
- - (Yellow) - Acknowledged Alarms Exist
- Lowest (Green) - No Alarms Exist



Figure 13.3 – Alarm Object

To view, acknowledge and/or clear alarms, the operator must access the alarm viewer. This is accomplished by touching an (enabled) alarm object. When accessed, the alarm viewer is displayed as pop-up alarm viewer dialog similar to that shown in Figure 13.6.

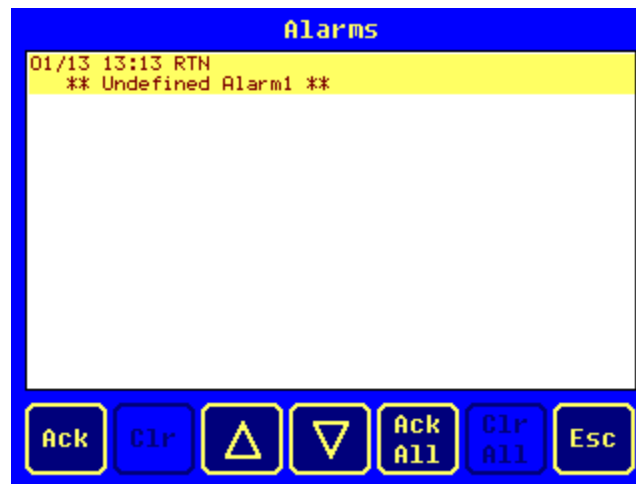

Figure 13.4 – Alarm Viewer

The currently selected entry is indicated by a yellow highlight which can be moved up or down by touching the arrow buttons or by directly touching an entry. If more entries exist than can fit on the page, a scroll bar is displayed on the right side that also indicates the current relative position.

The current state of the displayed alarm is indicated by its color and optionally by an abbreviated indicator after the date/time stamp (ALM, ACK, RTN). The operator can acknowledge an alarm by selecting it from the list and touching the ACK button. The operator can also clear an alarm if that function is enabled in the alarm object. If not enabled, the **C**lear buttons are grayed and do not respond to touch. Once view operations are complete, simply touch the *Esc* button to remove the pop-up alarm viewer.

Note that OCS registers %SR181 and %SR182 are available for ladder use, which indicate presence of unacknowledged or acknowledged alarm (respectively). The screen designer may implement these registers to switch screens or activate the beeper to attract the operator's attention.

13.9 Removable Media

The removable media object is generally used to inform the operator on the current state of the removable media device and allow access to its file structure. The removable media object is displayed as a button that changes colors to indicate the current state of the removable media device. The following indicates the device states and the default colors associated with these states.

- Highest (Red) - Device Error
- - (Yellow) - Device Full (threshold adjustable)
- Lowest (Green) - Device OK

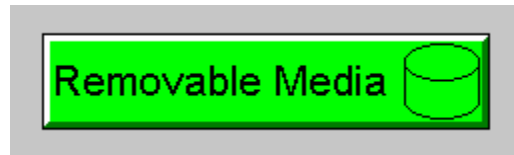

Figure 13.5 – Removable Media Object

To view and perform file operations, the operator must access the removable viewer. This is accomplished by either touching an (enabled) removable media object or through the system menu. When accessed, the removable media viewer is displayed as pop-up removable media dialog similar to that shown in Figure 13.8.

Note that the removable media object can be configured to open the removable media viewer at a certain directory complete with restrictions on transversing back up the file path. This may be used to restrict operator access to non-critical files.

Media Directory			
SCREEN00.BMP	153654	01-13-96	1:10p
SCREEN01.BMP	153654	01-13-96	1:13p
SCREEN26.BMP	153654	01-13-96	1:08p

Free: 992247808 Total: 992739328

Figure 13.6 – Removable media viewer

The currently selected entry is indicated by a yellow highlight which can be moved up or down by touching the arrow buttons or by directly touching an entry. If more entries exist than can fit on the page, a scroll bar is displayed on the right side that also indicates the current relative position.

File operations are accomplished by pressing the appropriate button at the bottom of the removable media viewer. The configuration of the removable media object that invokes the removable media viewer

defines what buttons are enabled and available to the user. A button is grayed and does not respond to touch if configured as disabled.

The  (Enter) button (if enabled) performs certain operations based on the selected file's type:

..	- change display to parent directory
<DIR>	- change display to child directory
bmp, jpeg	- display bitmap (if compatible format)
pgm	- load application (if compatible model and version)

Alternately, the (enter) button can be configured to simply load the ASCII representation of the file path (including the file name) to a group of OCS registers. That pathname can then be used by ladder for opening and manipulating that file.

Once view operations are complete, simply touch the *Esc* button to remove the pop-up removable media viewer.

If the removable media is used in an application, the removable media device requires changing by the operator, and the application is attempting to write to the removable media when it is removed, the screen designer should create objects that allow the operator to temporarily halt access to the removable media. This prevents corruption to the file system if the removable media is removed during a file write sequence. The graphic objects should set OCS register %SR174.1 (when requesting the card be removed) and provide an indicator based on OCS register %SR174.2 (which indicates that it is safe to remove the removable media).

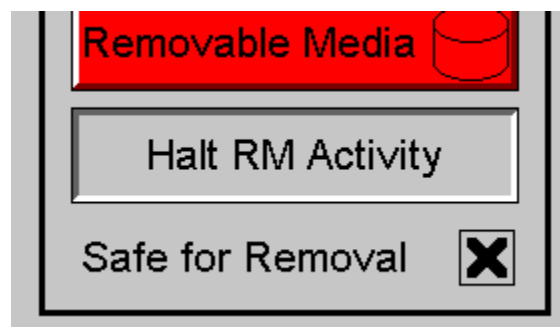

Figure 13.7 – Example application segment for safe removal of removable media

13.10 Screen Saver

The XL4 screen backlight life is typically 5 years when in continuous use. If the application does not require interaction with the XL4 for long periods of time, the backlight life can be extended by using the screen saver function. When enabled through the system menu, the backlight is shut off (screen goes black) after a specified time of no touch activity on the screen. When the screen saver shuts off the backlight, any operator touch on the screen or function keys reactivates the backlight.

Note that when the screen saver is active (backlight shut off), any initial touch activity on the screen (or function key) to reactivate the backlight is otherwise ignored by the XL4. Any additional touch activity is also ignored by the XL4 for approximately one second thereafter.

It is possible for the application to temporarily disable the screen saver by generating a positive transition to %SR57.16 (coil only) at a rate faster than the screen saver timeout value. This may be desired while waiting for alarm acknowledgement.

13.11 Screen Brightness

The XL4 provides a feature that allows screen dimming for night operation. To enable this feature, the application must access and control system register %SR57 (Display Backlight Brightness). Screen brightness is continuously variable by driving %SR57 through the range of 100 (full bright) to 0 (full off). It is left to the screen designer on if and how to present a Screen Brightness control to the user.

Note that backlight life may be shorted when screen is dimmed or screen brightness is varied on a repetitive basis.

INTENTIONALLY LEFT BLANK

CHAPTER 14: REGISTERS

14.1 Register Definitions

When programming the XL4 OCS, data is stored in memory that is segmented into different types. This memory in the controller is referred to as registers. Different groups of registers are defined as either bits or words (16 bits). Multiple registers can usually be used to handle larger storage requirements. For example 16 single bit registers can be used to store a Word or two 16 bit registers can be used to store a 32-bit value.

Below is a list of the type of registers found in the XL4 OCS.

%AI Analog Input

16-bit input registers used to gather analog input data such as voltages, temperatures, and speed settings coming from an attached device.

%AQ Analog Output

16-bit output registers used to send analog information such a voltages, levels or speed settings to an attached device.

%AIG Global Analog Input

Specially defined 16-bit input registers that come from the network.

%AQG Global Analog Output

Specially defined 16-bit output registers that go to the network.

%D Display Bit

These are digital flags used to control the displaying of screens on a unit which has the ability to display a screen. If the bit is SET, the screen is displayed.

%I Digital Input

Single-bit input registers. Typically, an external switch is connected to the registers.

%IG Global Digital Input

Specially defined single-bit inputs that come from the network.

%K Key Bit

Single-bit flags used to give the programmer direct access to any front panel keys appearing on a unit.

%M Retentive Bit

Retentive single-bit registers.

%Q Digital Output

Single-bit output registers. Typically, these bits are connected to an actuator, indicator light or other physical outputs.

%QG Global Digital Output

Specially defined single-bit outputs that go to the network.

%R General Purpose Register

Retentive 16-bit registers.

%S System Bit

Single-bit bit coils predefined for system use.

%SR System Register

16-bit registers predefined for system use.

%T Temporary Bit

Non-retentive single-bit registers.

14.2 Useful %S and %SR registers

Table 14.1 – Common %S Register Definitions	
Register	Description
%S1	Indicate First Scan
%S2	Network is OK
%S3	10mS timebase
%S4	100mS timebase
%S5	1 second timebase
%S6	I/O is OK
%S7	Always ON
%S8	Always OFF
%S9	Pause 'n Load soon
%S10	Pause 'n load done
%S11	I/O being forced
%S12	Forcing is enabled
%S13	Network I/O is OK
%S16	Ethernet COM module is OK

Table 14.2 – %SR Registers				
Register	Name	Description	Min Val	Max Val
%SR1	USER_SCR	Current User Screen Number	1	1023
%SR2	ALRM_SCR	Current Alarm Screen Number (0=none)	0	1023
%SR3	SYS_SCR	Current System Screen Number (0=none)	0	14
%SR4	SELF_TEST	Bit-Mapped Self-Test Result	0	65535
%SR5	CS_MODE	Control Station Mode (0=Idle, 1=Do I/O, 2=Run)	0	2
%SR6	SCAN_RATE	Average Scan Rate (/ 10)	-	1000
%SR7	MIN_RATE	Minimum Scan Rate (/ 10)	-	1000
%SR8	MAX_RATE	Maximum Scan Rate (/ 10)	-	1000
%SR9-10	EDIT_BUF	Data Field Edit Buffer	0	2 ³² -1
%SR11-12	LADDER_SIZE	Ladder Code Size	2	256K
%SR 13-16	Reserved	-	-	-
%SR17-18	IO_SIZE	I/O Configuration Table Size	16	127K
%SR19-20	NET_SIZE	Network Configuration Table Size	34	1K
%SR21-22	SD_SIZE	Security Data Table Size	-	-
%SR23	LADDER_CRC	Ladder Code CRC	0	65535
%SR 24-25	Reserved	-	-	-
%SR26	IO_CRC	I/O Configuration Table CRC	0	65535
%SR27	NET_CRC	Network Configuration Table CRC	0	65535
%SR28	SD_CRC	Security Data Table CRC	0	65535
%SR29	NET_ID	This Station's Primary Network ID (CsCAN)	1	253
%SR30	NET_BAUD	Network Baud Rate (CsCAN) (0=125KB; 1=250KB; 2=500KB; 3=1MB)	0	3
%SR31	NET_MODE	Network Mode (0=network not required; 1=network)	0	3

Table 14.2 – %SR Registers				
Register	Name	Description	Min Val	Max Val
		required; 2=network optimized; 3=network required and optimized)		
%SR32	LCD_CONT	LCD Display Contrast setting	0	255
%SR33	FKEY_MODE	Function Key Mode (0=Momentary; 1=Toggle)	0	1
%SR34	SERIAL_PROT	RS232 Serial Protocol Mode (0=Firmware Update (RISM); 1=CsCAN; 2=Generic (Ladder- Controlled); 3=Modbus RTU; 4=Modbus ASCII)	0	4
%SR35-36	SERIAL_NUM	This Station's 32-bit Serial Number	0	2 ³² -1
%SR37	MODEL_NUM	This Station's Binary Model Number	0	65535
%SR38	ENG_REV	Firmware Rev Number (/ 100)	0000	9999
%SR39	CPLD_REV	BIOS Rev Number (/ 100)	000	255
%SR40	FPGA_REV	FPGA Image Rev Number (/ 10)	000	255
%SR41	LCD_COLS	Vertical Pixel Count		
%SR42	LCD_ROWS	Horizontal Pixel Count		
%SR43	KEY_TYPE	Keypad Type		
%SR44	RTC_SEC	Real-Time-Clock Second	0	59
%SR45	RTC_MIN	Real-Time-Clock Minute	0	59
%SR46	RTC_HOUR	Real-Time-Clock Hour	0	23
%SR47	RTC_DATE	Real-Time-Clock Date	1	31
%SR48	RTC_MON	Real-Time-Clock Month	1	12
%SR49	RTC_YEAR	Real-Time-Clock Year	1996	2095
%SR50	RTC_DAY	Real-Time-Clock Day (1=Sunday)	1	7
%SR51	NET_CNT	Network Error Count	0	65535
%SR52	WDOG_CNT	Watchdog-Tripped Error Count	0	65535
%SR53-54	BAD_LADDER	Bad Ladder Code Error Index	0	65534
%SR55	F_SELF_TEST	Filtered Bit-Mapped Self-Test Result	0	65535
%SR56	LAST_KEY	Key Code of Last Key Press or Release	0	255
%SR57	BAK_LITE	LCD Backlight Dimmer Register 0 = 0% On; 25=25% On; 100-255 = 100% On	0	255
%SR58	USER_LEDS	User LED Control / Status	0	65535
%SR59-60	Reserved	-	-	-
%SR61	NUM_IDS	This Station's Number of Network IDs	1	253
%SR62	NUM_IDS	This Station's Number of Network IDs	1	253
%SR63	SS_BASE	SmartStack I/O Base Selector	0	7
%SR64	SS_STATUS	SmartStack I/O Base Status	0	2
%SR65-76	SS_INFO_1	SmartStack I/O Module #1 Information Structure	-	-
%SR77-88	SS_INFO_2	SmartStack I/O Module #2 Information Structure	-	-
%SR89-100	SS_INFO_3	SmartStack I/O Module #3 Information Structure	-	-
%SR101-112	SS_INFO_4	SmartStack I/O Module #4 Information Structure	-	-
%SR113-114	GOBJ_SIZE	Graphics Object Table Size	8	256K
%SR115-116	GSTR_SIZE	Graphics String Table Size	8	128K
%SR117-118	GBMP_SIZE	Graphics Bitmap Table Size	4	256K
%SR119-120	GTX_T_SIZE	Graphics Text Table Size	8	128K
%SR121-122	GFNT_SIZE	Graphics Font Table Size	8	256K
%SR123-124	PROT_SIZE	Protocol Table Size	16	64K
%SR125	GOBJ_CRC	Graphics Object Table CRC	0	65535
%SR126	GSTR_CRC	Graphics String Table CRC	0	65535
%SR127	GBMP_CRC	Graphics Bitmap Table CRC	0	65535
%SR128	GTX_T_CRC	Graphics Text Table CRC	0	65535
%SR129	GFNT_CRC	Graphics Font Table CRC	0	65535
%SR130	PROT_CRC	Protocol Table CRC	0	65535
%SR131-163	Reserved	-	-	-
%SR164.3		Read bit indicating Auto Restore of Register Data		

Table 14.2 – %SR Registers				
Register	Name	Description	Min Val	Max Val
		has been performed (Fail Safe)		
%SR164.4		Read bit indicating Backup of Register Data has been performed (Fail Safe)		
%SR164.5		Enable AUTORUN (Fail Safe)		
%SR164.6		Enable AUTOLOAD (Fail Safe)		
%SR164.7		Backup trigger bit		
%SR164.8		Clear Backup trigger bit		
%SR164.9		MAKE_CLONE trigger bit		
%SR164.10		LOAD_CLONE trigger bit		
%SR164.11		Status indicating Make Clone Fail (This bit goes high when Make / Create clone fails)		
%SR164.12		Status indicating Load Clone Fail (This bit goes high when Load clone fails)		
%SR165-174	Reserved			
%SR175	Removable Media	Current Removable Media interface status	0	6
%SR176-177	Removable Media	Indicates free space on the Removable Media card in K bytes.	0	2 ³¹
%SR178-179	Removable Media	Indicates the total card capacity in K bytes.	0	2 ³¹
%SR180	Reserved	-	-	-
%SR181	ALM_UNACK	Unacknowledged Alarm (high bit indicates what group #)		
%SR182	ALM_ACT	Active Alarm (high bit indicates what group #)		
%SR183	SYS_BEEP	System Beep Enable (0=disabled; 1=enabled)		
%SR184	USER_BEEP	Software configurable (0=OFF; 1=ON)		
%SR185	SCR_SAVER	Screen Saver Enabled (0=disabled; 1=enabled)		
%SR186	SCR_SA_TM	Screen Saver Time in minutes (delay)		
%SR187	NET_USE	Average Net Usage of all units on the CAN network		
%SR188	NET_MIN	Minimum Net Usage of all units on the CAN network		
%SR189	NET_MAX	Maximum Net Usage of all units on the CAN network		
%SR190	NT_TX_AVG	Average Net Usage of this unit		
%SR191	NT_TX_MIN	Minimum Net Usage of this unit		
%SR192	NT_TX_MAX	Maximum Net Usage of this unit		

For additional information on system bits and registers, refer to the on-line help found in Cscope.

14.3 Register Map for XL4 OCS I/O

Fixed Address	Digital/Analog I/O Function	XL4 Model			
		2	3	4	5
%I1	Digital Inputs	1-12	1-12	1-24	1-12
	Reserved	13-32	13-31	25-31	13-31
	ESCP Alarm	n/a	32	32	32
%Q1	Digital Outputs	1-6	1-12	1-16	1-12
	Reserved	7-24	13-24	17-24	13-24
%AI1	Analog Inputs	1-4	1-2	1-2	1-2
	Reserved	5-12	3-12	3-12	3-12
%AQ1	Reserved	n/a	1-8	1-8	1-8
	Analog Outputs	n/a	n/a	n/a	9-10

Reserved areas maintain backward compatibility with other XL Series OCS models

14.4 Resource Limits

Table 14.4 – Resource Limits	
Resource	Value
%S	13
%SR	192
%T	16000
%M	16000
%R	49999
%K	5
%D	1023
%I	2048
%Q	2048
%AI	512
%AQ	512
%IG	64 (per ID)
%QG	64 (per ID)
%AIG	32 (per ID)
%AQG	32 (per ID)
Ethernet	CsCAN, Ping, EGD, SRTP, Modbus TCP Master (Downloadable protocol) & Slave, Ethernet IP, FTP, or HTTP @ 10 MBd or 100 MBd
CsCAN	125 kBd, 250 kBd, 500 kBd, or 1 MBd
Serial Ports	1 RS-232, 1 RS-485 Ports
IDs Per CsCAN Network	64 w/o repeat (253 w/ 3 repeaters)
Keypad	5 keys (4 fn keys and a System Key)
Display	320 x 240 3.5" TFT, 64K colors
Screen Memory	64 MB
User Screens	1023
Data Fields Per User Screen	50
Ladder Code	1024 kB

NOTES

CHAPTER 15: CSCAPE CONFIGURATION

15.1 Overview

XL4 OCS hardware is programmed with a Windows based PC application called Cscape. This application can be used to program, configure, monitor and debug all aspects of the XL4 OCS unit. Please see the on-line help provided with Cscape for additional details.

15.2 Cscape Status Bar

When the XL4 OCS is connected to a PC using Cscape software a Status Bar appears at the bottom of the screen. The Cscape Status Bar can be used to determine if communications have been established between the XL4 OCS and the Cscape program. Components of the Cscape Status Bar are explained below.

Message Line -

The contents of these messages are context sensitive. The Message line can be empty.

Equal Indicator – indicates whether the current program in Cscape is equal to the program stored in the Target Controller.

- If **Equal**, the program in Cscape is the same as the program stored in the Target Controller.
- If **Not Equal**, the program in Cscape is not the same as the program stored in the Target Controller.
- If **Unknown**, there may have been a change since the last time the program in Cscape was compared to the Target Controller.

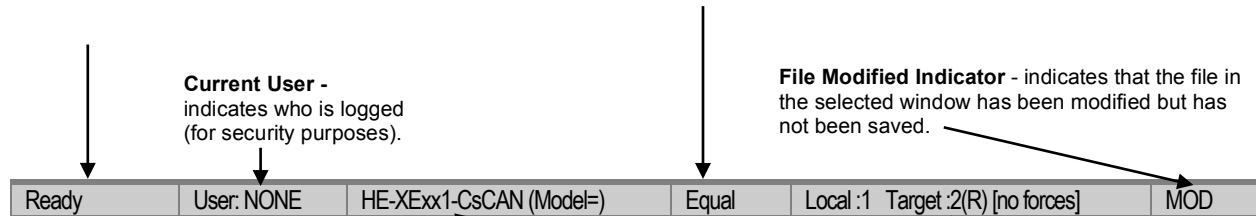

Current User - indicates who is logged (for security purposes).

File Modified Indicator - indicates that the file in the selected window has been modified but has not been saved.

Controller Model - Network (Model Confirmation)

- **Controller Model** indicates the controller model for which the program in Cscape is configured.
- **Network** indicates the type of network that the program in Cscape expects to use (e.g., CsCAN).
- **(Model Confirmation)** provides the following indications:
 - **(Model=)** - the actual Target Controller matches the configured Controller Model and Network.
 - **(Model Not=)** – the actual Target Controller does not match the configured Controller Model and Network.
 - **(Model ?)** – there may have been a change since the last time the Target Controller was compared to the configured Controller Model and Network.

Communications Status - indicates the current status of the “pass through” Connector.

- **Local: xx** – indicates the Network ID of the OCS to which the Cscape program is physically connected through its serial port. It can serve as a pass through device to other nodes on the network.
- **Target: yy(R)** – indicates the Network ID of the device with which the Cscape program is exchanging data.
 - Note:** The **Local** unit and **Target** unit can be the same unit or they can be separate units.

The following are status indicators:

- (R) – Running
- (D) - Do I/O
- (I) – Idle
- (?) – Cscape is not communicating with the remote unit.
- [no forces] – indicates no I/O has been forced.

15.3 Establishing Communications

The preferred method of communicating between Cscape and an XL4 OCS is via USB port. The XL4 OCS can communicate with Cscape using USB to USB, USB to serial adapters, serial port communications via MJ1 Port, Ethernet (with an Ethernet adapter board), onboard Ethernet Port), CAN (CsCAN) or modems. For communications other than USB or the MJ1 port please refer to the manual which ships with the communications adapter hardware being used for programming.

To communicate with the XL4 via USB you will need the automated driver installer located on the Horner APG web site.

For XL4 use Cscape Ver 9.30 SP3 or newer.

Next, connect a PC's (Personal Computer running a Windows Microsoft operating system) USB port via USB cable to the USB mini B port on the XL4 OCS.



Figure 15.1 – USB Programming Connector

The PC will detect a new device has been plugged into the USB port.

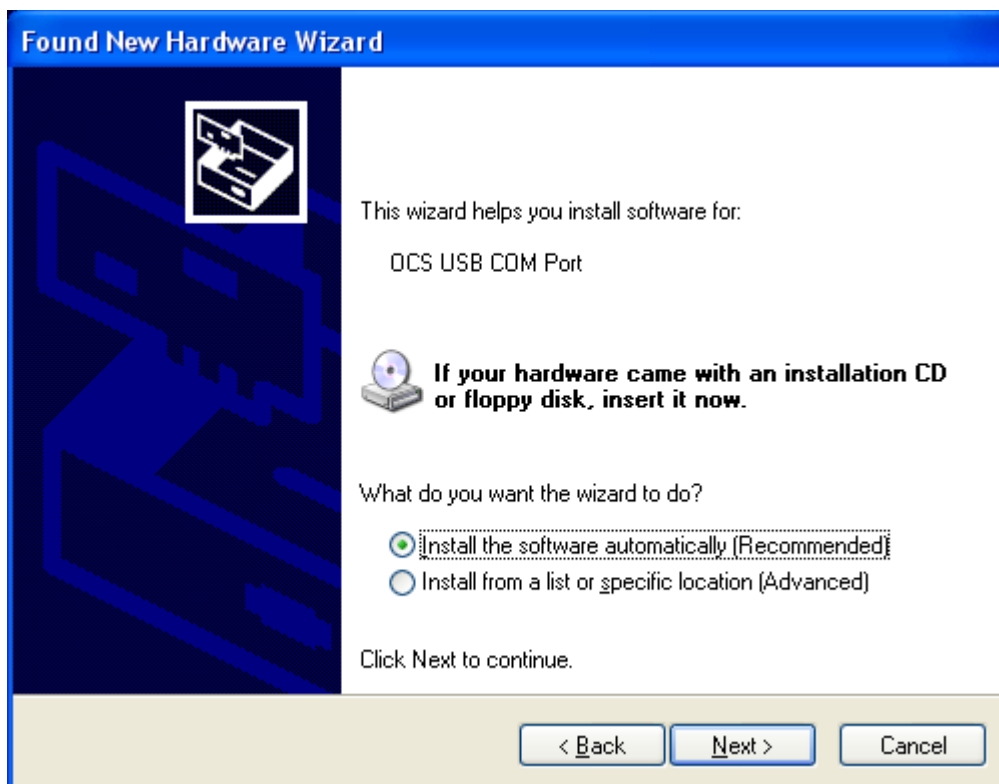





Now that the XL4 is plugged in, go to Cscape, Tools, Application Settings, Communications and choose the USB port (in this example Com 3).

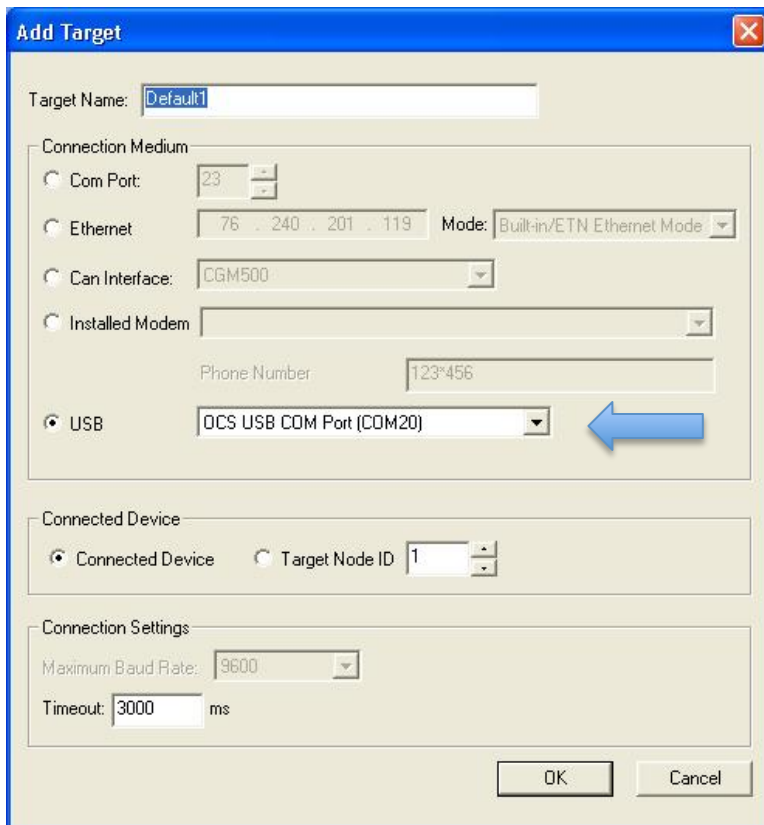
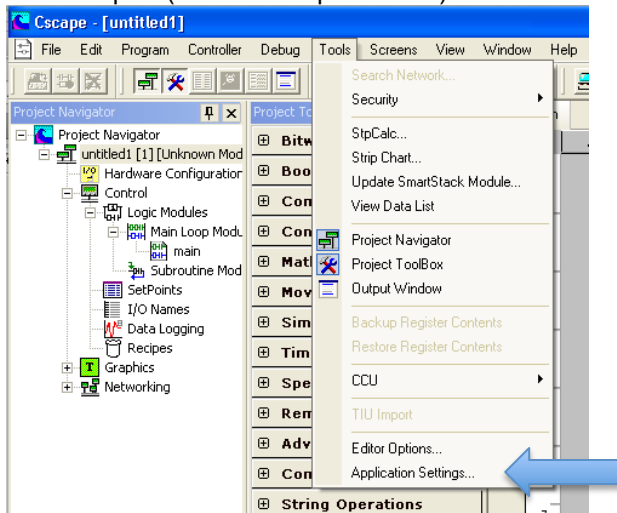

If communications are successful, the target indicator should show the mode of the controller **Target: yy(R)** as shown in the status section [above](#) in this chapter, section [Cscape Status Bar](#).

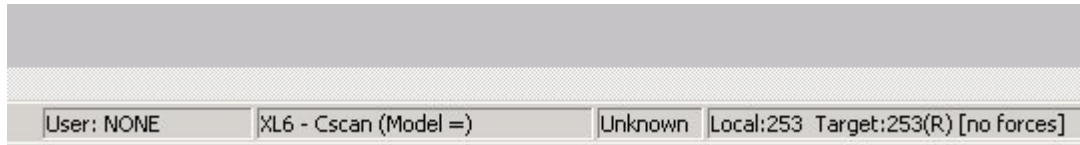

If the controller is not communicating you may need to set the target ID of the controller in Cscape or on the unit. The **Target ID** allows directing communications to a particular unit when multiple units are connected via a CsCAN network. Units without CsCAN network ports respond to any network ID and do not require the ID to be configured.

To check or change the ID on the XL4 OCS, press the system menu key.



The first item in the menu is **Set Networks**. Pressing **Enter** allows you to view or modify the ID of the unit.

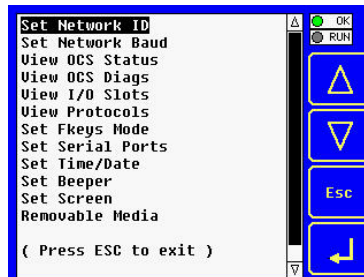

To change the Target ID of Cscape use the **Controller | Set Target Network ID** dialog.



15.3.1 Communicating via MJ1 Serial Port

Start by configuring Cscape to use the correct communications port. This can be done using the **Tools | Options | Communication Port** dialog in Cscape.

Next connect the PC's serial port to the port labeled MJ1 on the XL4.

If communications are successful, the target indicator should show the mode of the controller **Target: yy(R)** as shown in the status section [above](#).

If the controller is not communicating you may need to set the target ID of the controller in Cscape or on the unit. The **Target ID** allows directing communications to a particular unit when multiple units are connected via a CsCAN network. Units without CsCAN network ports respond to any network ID and do not require the ID to be configured.

To check or change the ID on the XLe/XLt, press the UP and DOWN keys on the XLe/XLt simultaneously to enter the system menu. The first item in the menu is Set Network ID.

Pressing Enter allows you to view or modify the ID of the unit.

To change the Target ID of Cscape use the Controller | Set Target Network ID dialog.

15.3.2 Communicating via On Board Ethernet Port

From Cscape go to Controller -> I/O Configure and do auto configuration for the connected controller, Click on Config of Ethernet & go to Module Setup.

You can temporarily set the IP address, Net Mask and Gateway of the controller from the system menu under the Set Networks menu item. Once running or power cycled the configuration will come from the Cscape configuration stored in the unit.

In Module configuration dialog go to IP Address field enter unused IP Address and configure unused registers in Register field & then click OK. Screen shot for the same as follows:

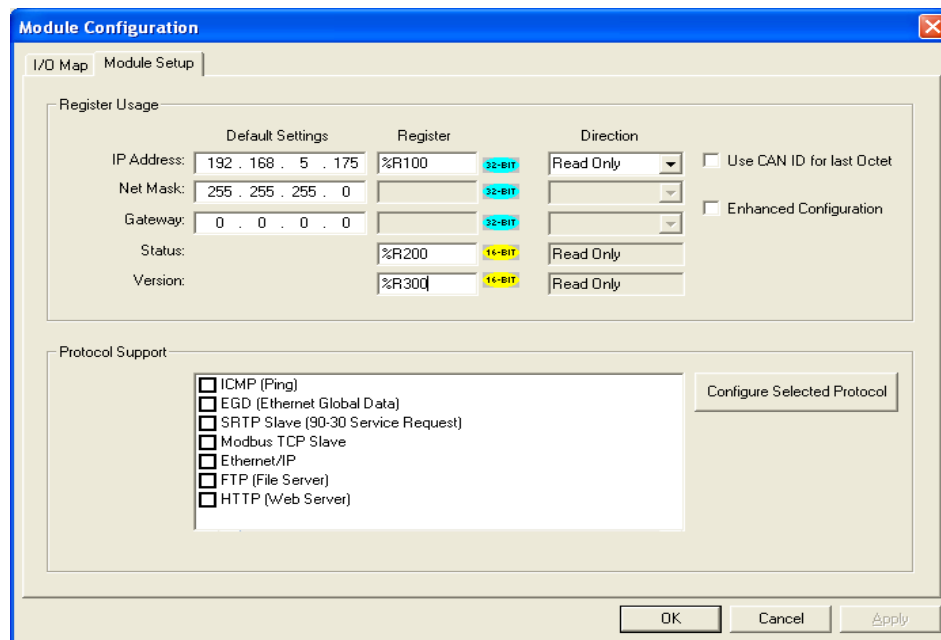

Download the configuration in to Controller. Connect LAN cable to the Controller in default LAN Port.

From Cscape go to Tools -> Editor Options -> Communication Port -> configure. Select Ethernet and enter IP address which is configured in the file. Select mode as XL Series mode from drop down list.

The controller should get connected to Cscape. If communications are successful, the target indicator should show the mode of the controller Target: yy(R) as shown in the status section above.

15.5 Configuration

An overview of configuration:

- (1) Start the configuration by selecting the **Controller | I/O Configure** menu item.
- (2) If the XL4 OCS is connected to the PC press the **Auto Config System** button to automatically detect the Base model, I/O and any communication options.
- (3) If the XL4 OCS is **not** connected press the **Config** button to the right of the top of the unit. This allows the base CPU to be selected.
- (4) Select either **XL4 OCS Cscan** from the type drop down box.
- (5) Once the type of XL4 OCS is selected, the model # drop down box will provide the XL4 OCS model numbers from which to choose from.
- (6) Once the XL4 OCS CPU is selected, press **OK** to exit the dialog and configure the I/O that is present in the first slot.
- (7) The I/O configure dialog (Specifically the **Module Setup** tab) provides 4 buttons to configure all of the I/O. Go through each area of I/O and configure it.
- (8) Once done configuring the I/O OK out of configuration dialogs.

Configuring the XL4 OCS I/O has four main portions that are covered in this chapter. For additional information on I/O, refer the chapters covering General I/O or High Speed I/O in this manual.

The four areas of I/O configuration are:

- Digital in / HSC
- Digital out / PWM
- Analog in
- Analog out

15.6 Digital Input / HSC Configuration

The following figure illustrates the **Digital Input / HSC Configuration** dialog.

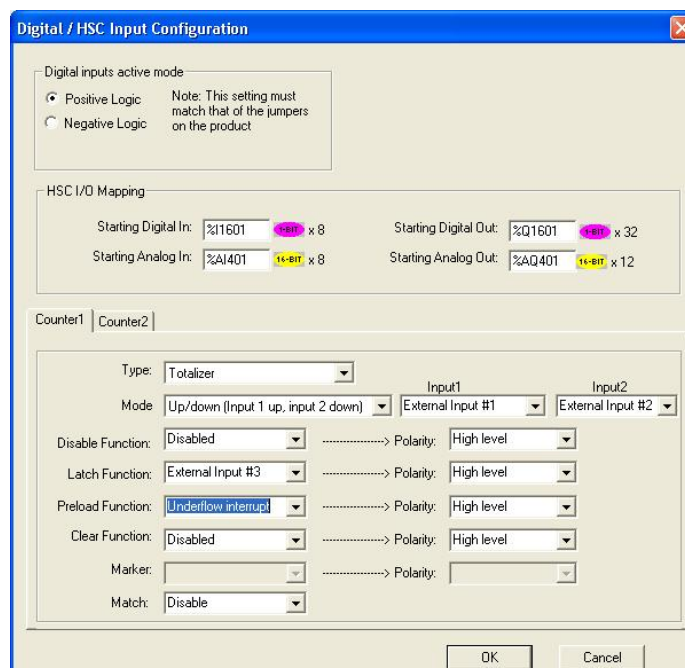

Figure 15.2 – Digital Input / HSC Configuration Dialog

The Active mode group box allows the user to select if inputs are active high (Positive logic) or active low (Negative logic). It is important that this setting match what the jumper settings are on the hardware.

The High Speed Counters group box contains all of the windows that are used for configuring the 4 available high speed counters on the XL4 OCS. In configuring a counter, the user needs to set the type, mode, and counts per rev.

The type drop down includes the following options:

- Disabled
- Frequency Measurement
- Period Measurement
- Totalize
- Pulse Width Measurement
- Quadrature

15.7 Digital Output / PWM Configuration

The following figure illustrates the **Digital Output / PWM Configuration** dialog.

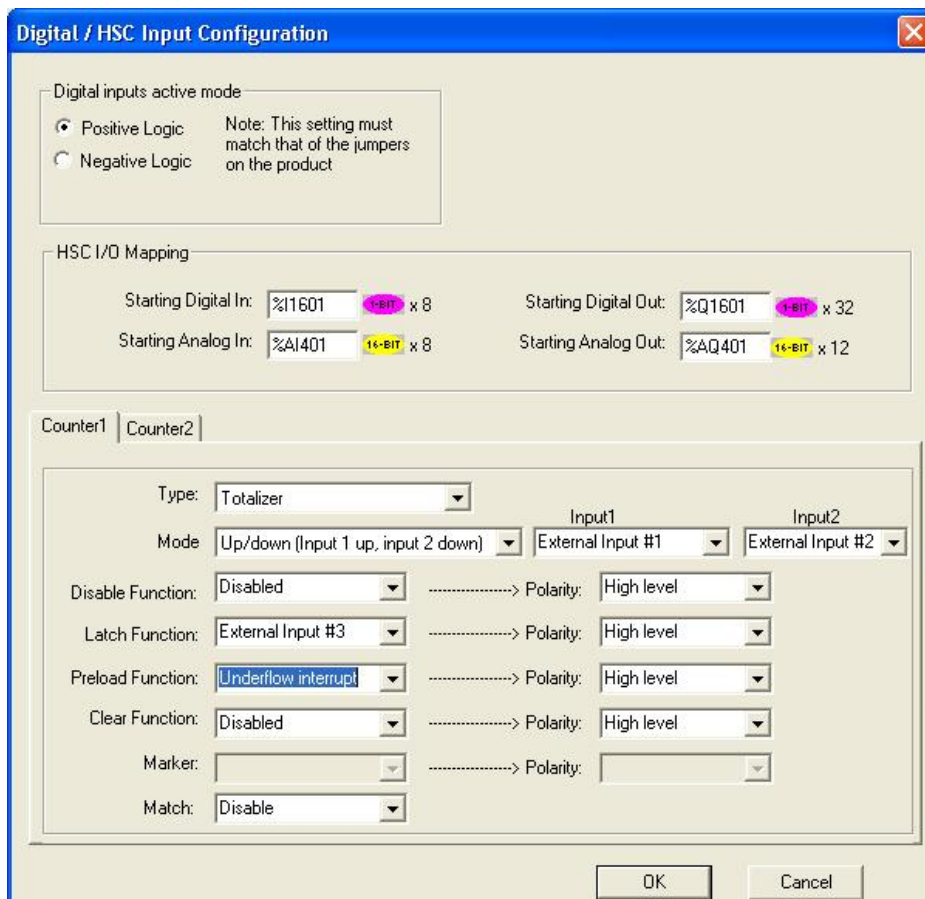

Figure 15.3 – Digital Output / PWM Configuration Dialog

The **Q1** and **Q2** group boxes allow the user to specify the operation of the multi-function outputs.

The **PWM State On Controller Stop** group box contains items that allow the user to specify how the PWM outputs behave when the controller is stopped. These items can either hold their value or default to some value when the controller is stopped.

Note that the PWM outputs are set to the OFF state at power-up and during program download and remain in that state until the unit is placed in RUN

The **Output State On Controller Stop** group box contains items to allow the user to specify how the remaining digital outputs behave when the controller is stopped. These items can either hold their value or default to some value when the controller is stopped.

15.8 Analog Input Configuration

The following figure illustrates the **Analog Input Configuration** dialog.

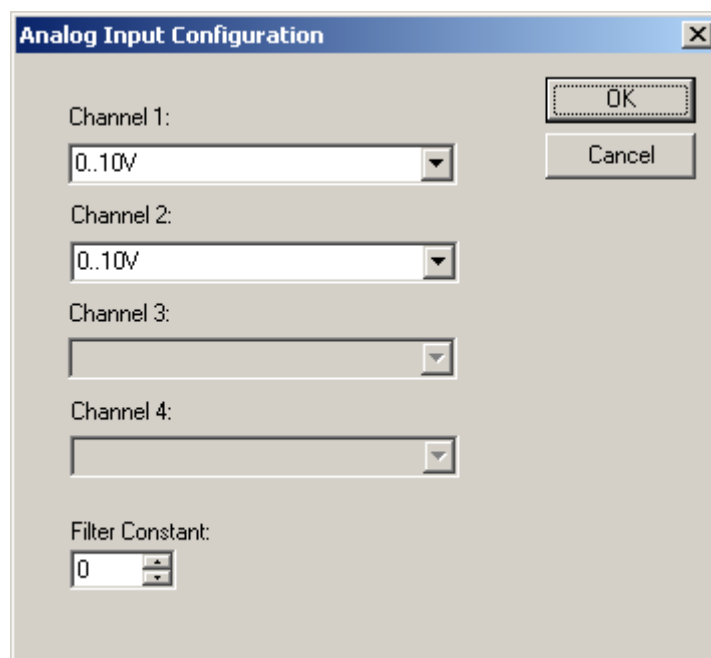

Figure 15.4 – Analog Input Configuration Dialog

The **Channel x** drop down windows allow the user to specify the mode for each analog input to operate. The **Channel x** drop down windows are enabled/disabled according to which model is being configured. All of the models have the following modes available:

- 0..10V
- 0..20mA
- 4..20mA

On model 005, channels 3 and 4 also have the following modes available:

- 100mV
- PT100 DIN RTD, 1/20°C
- Type J Thermocouple, 1/20°C
- Type K Thermocouple, 1/20°C

- Type N Thermocouple, 1/20 °C
- Type T Thermocouple, 1/20 °C
- Type E Thermocouple, 1/20 °C
- Type R Thermocouple, 1/20 °C
- Type S Thermocouple, 1/20 °C
- Type B Thermocouple, 1/20 °C

The **Filter Constant** provides filtering to all channels.

15.9 Analog Output Configuration

The following figure illustrates the **Analog Output Configuration** dialog.

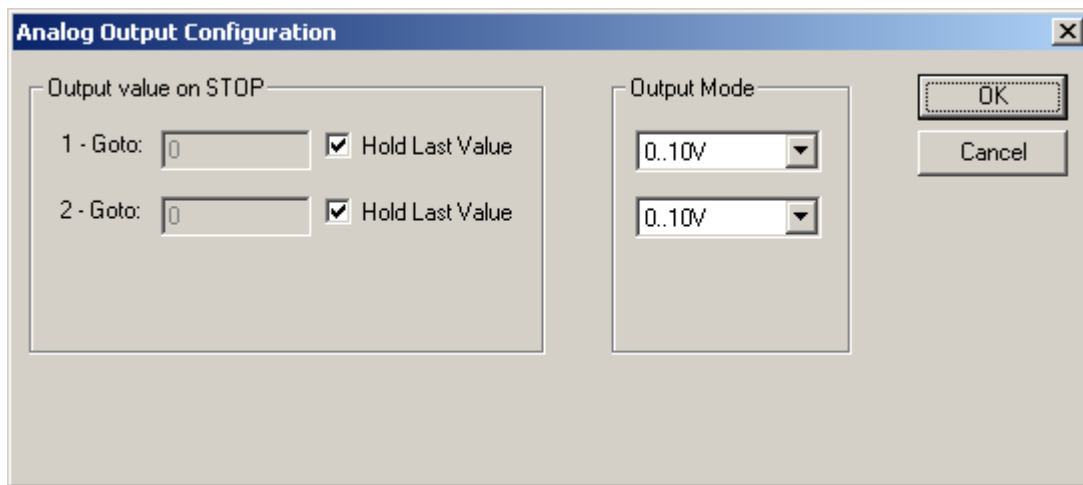

Figure 15.5 – Analog Output Configuration Dialog

The **Output value on Stop** group box contains items that allow the user to specify how the analog output channels behave when the controller is stopped. The outputs can either hold their value or default to a value when the controller is stopped.

The **Output Mode** group box allows the user to select the operating modes for each of the analog outputs. The modes include the following:

- 0..10V
- 0..20mA
- 4..20mA

CHAPTER 16: FAIL – SAFE SYSTEM

16.1 Overview

The Fail-Safe System is a set of features that allow an application to continue running in the event of certain types of "soft" failures. These "soft" failures include:

- Battery power loss
- Battery-Backed Register RAM or Application Flash corruption due to, for example, an excessive EMI event.

The Fail-Safe System has the following capabilities:

- Manually backup the current Battery-Backed RAM Register Settings into Flash memory.
- Manually restore Register Settings from the values previously backed up in Flash to Battery-Backed RAM.
- Detect corrupted Register Settings at power-up and then automatically restore them from Flash.
- Detect corrupted or empty application in Flash memory at power-up and then automatically load the AUTOLOAD.PGM application file from Removable Media (Compact Flash or MicroSD).
- If an automatic Register Restore or Application Load occurs, the OCS can automatically be placed in RUN mode

The fail-safe system can be accessed by going to the system menu of the controller. A new menu "Fail-Safe System" has been added at the end of the main system menu for this. Selecting "Fail-Safe System" menu will open the following menu screen:

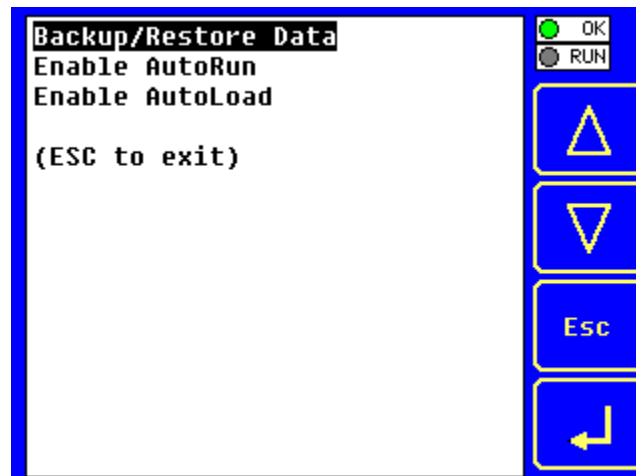

Figure 16.1 – Fail – Safe System Menu

16.2 Settings

To use the fail – safe feature, the user needs to do the following:

1. Backup the current Battery-Backed RAM Register contents in On-Board Flash memory using System Menu options.
2. From Cscope, create AUTOLOAD.PGM for the application program using 'Export to Removable Media'.
3. Place the Removable Media with AUTOLOAD.PGM in the device.
4. Set the 'Enable AutoLoad' option in the device to YES.
5. Set the 'Enable AutoRun' option to YES if the controller needs to be placed in RUN mode automatically after automatic restore of data or AutoLoad operation.

16.3 Backup / Restore Data

Selecting this option brings up a screen having four operations:

- Backup OCS Data.
- Restore OCS Data.
- Clear Backup Data.
- Exit



Figure 16.2 – Backup / Restore Data

Backup OCS Data:

When initiated, this will allow the user to manually copy Battery-Backed RAM contents on to the onboard FLASH memory of the OCS. This will have the effect of backing up all the registers and controller settings (Network ID, etc.) that would otherwise be lost due to a battery failure. %SR164.4 is set to 1 when backup operation is performed.



Figure 16.3 – Backup Registers

Restore OCS Data:

When initiated, this will allow the user to manually copy the backed up data from the onboard FLASH to the Battery-Backed RAM.

A restore operation will be automatically initiated if a backup has been previously created and on power-up the Battery-Backed RAM registers fail their check.

The following process will be followed for restoring data:

- The controller will be placed in IDLE mode.
- Data will be copied from onboard FLASH to OCS Battery-Backed RAM
- The controller will reset.
- The controller will be put in RUN mode if the AutoRun setting is 'Yes' else it will remain in IDLE mode.



Figure 16.4 – Restore OCS Data

%SR164.3 is set to 1 only when an automatic restore operation is performed - not on a manual one. This bit is reset to 0 when a new backup is created.

Restoring of data can be manually performed by selecting RESTORE option from the Backup / Restore Data menu. This will cause the controller to reset.

Clear Backup Data:

When initiated, the backup data will be erased from the onboard Flash and no backup will exist. %SR164.4 and %SR164.3 is reset to 0 when backed up data is erased.



Figure 16.5 – Clear Backup Data

Exit: Goes back to the previous screen.

The OCS follows the following sequence in execution of Automatic Restore:

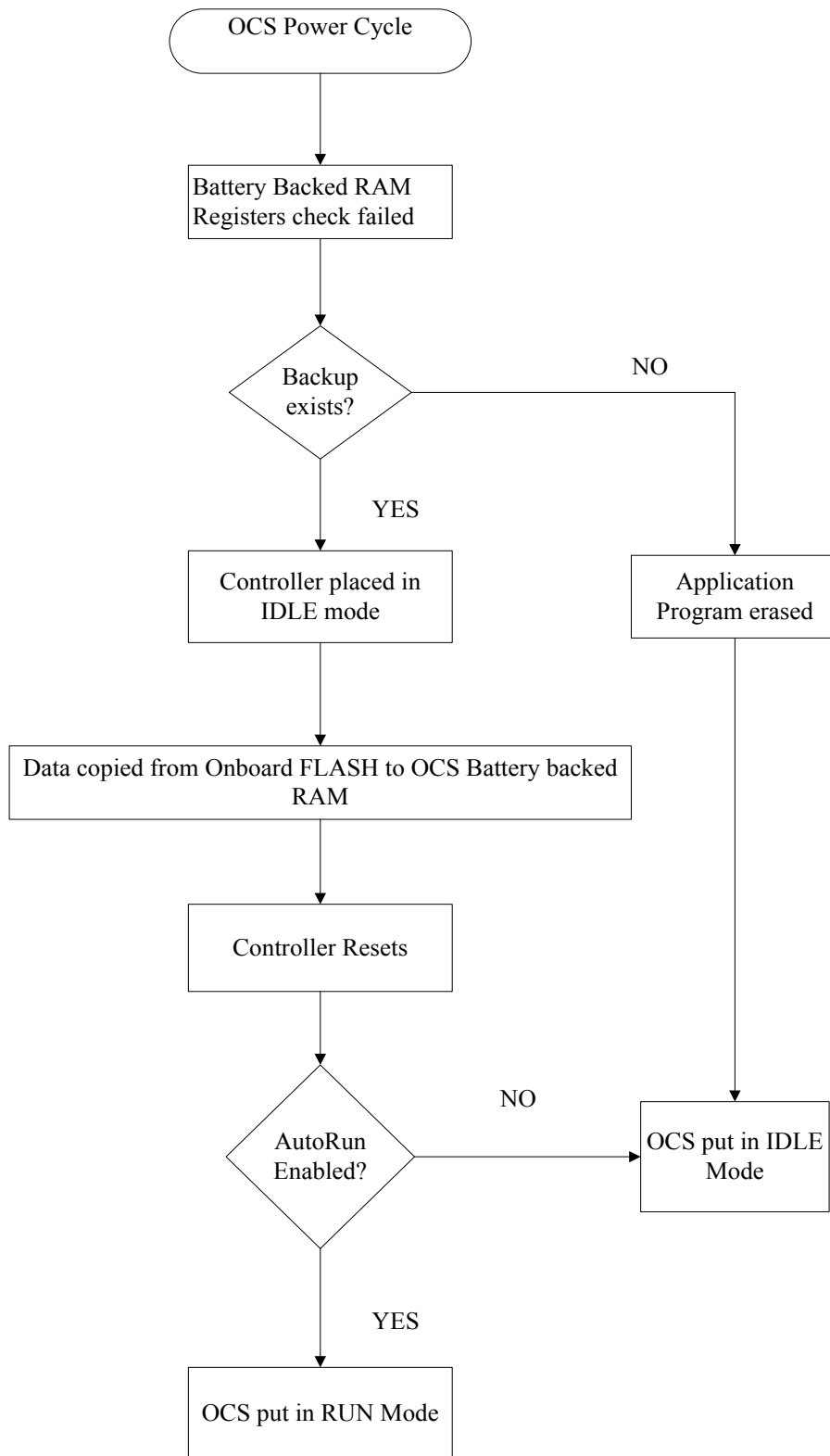

Figure 16.6 – Flow Chart for Automatic Restore

16.4 AutoLoad

This system menu option allows the user to specify whether the OCS automatically loads the application AUTOLOAD.PGM located in Removable Media.

When the AutoLoad setting is enabled (set to YES), it can either be manually initiated or automatically initiated at power-up.

The automatic initiation will happen only in the following two cases:

- When there is no application program in the OCS and a valid AUTOLOAD.PGM is available in the removable media of the device.
- When the program residing in onboard memory is corrupted and a valid AUTOLOAD.PGM is available in the removable media of the device.

AutoLoad can be manually initiated when the SYS-F3 key is pressed (OCS can be in any of the following mode – Idle / Run / DOIO). This also requires a valid AUTOLOAD.PGM to be present in the removable media of the device.

When the AutoLoad setting is not enabled (set to NO), OCS will be in IDLE mode and the application is not loaded.

If the AUTOLOAD.PGM is security enabled, the user will be prompted to enter the password before loading the application. The application will be loaded from the Removable media only after getting the correct password.

%SR164.6 can be set to enable AutoLoad feature.

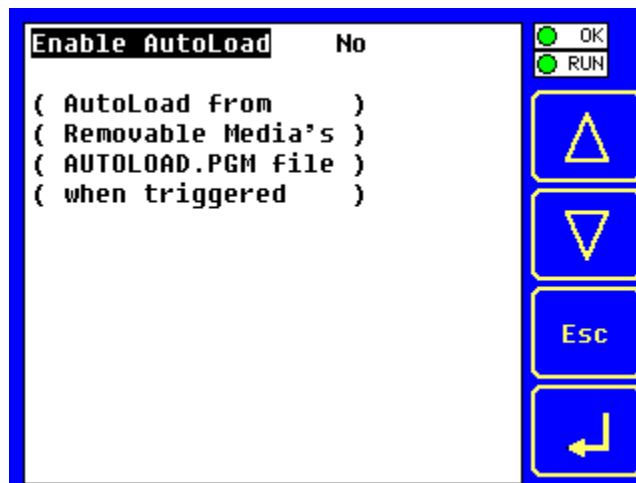

Figure 16.7 – AutoLoad Menu

The OCS follows the following sequence in execution of AutoLoad:

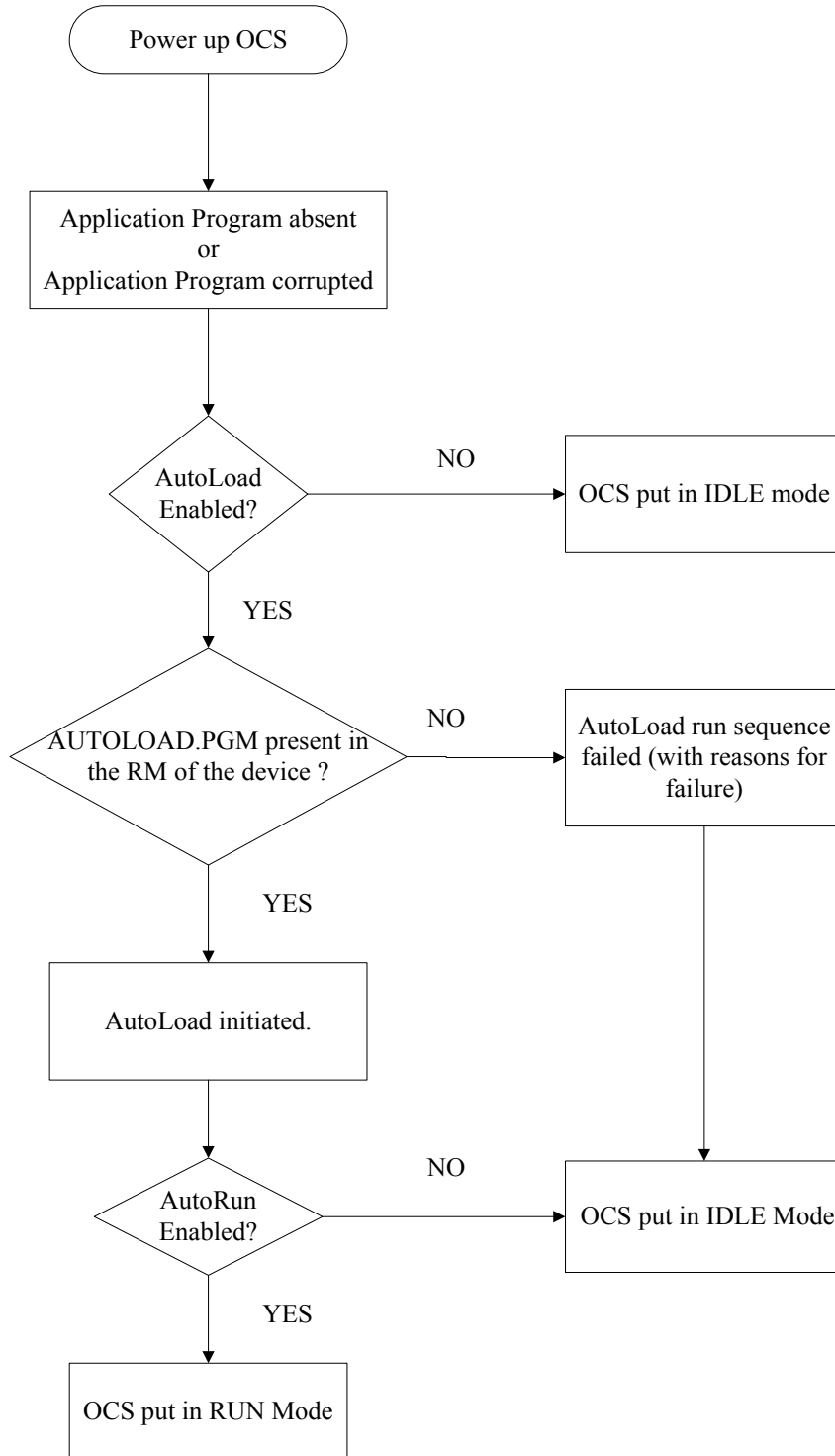

Figure 16.8 – Flow Chart for AutoLoad

16.5 AutoRun

This system menu option, when enabled (YES), allows the user to automatically place the OCS into RUN mode after the AutoLoad operation or automatic Restore Data operation.

When the AutoRun setting is disabled (NO), the OCS remains in the IDLE mode after a Restore Data or AutoLoad operation.

%SR164.5 can be set by putting the system into RUN mode automatically, once an AutoLoad has been performed or an Automatic Restore has occurred.

If for any reason the AutoLoad-Run (Loading the AUTOLOAD.PGM automatically and OCS put in RUN mode) sequence does not succeed, a pop-up message box saying "AUTO-LOAD-RUN SEQUENCE FAILED" will be displayed. It will also show the reason for its failure. On acknowledging this message box the AutoLoad-Run sequence will be terminated, controller will return to the first user-screen and will be placed in IDLE mode.

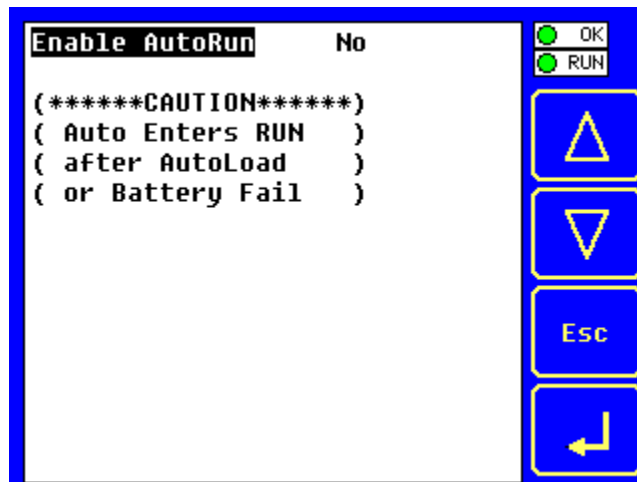

Figure 16.9 – AutoRun Menu

CHAPTER 17: CLONE UNIT

17.1 Overview

'Clone Unit' feature allows the user to "clone" the OCS of the exact same model. This feature "clones" application program and unit settings stored in Battery backed RAM of an OCS into the RM (refer Removable Media [Chapter 9](#) for details in using RM). It can then be used to clone a different OCS (exact same model).

This feature can be used for:

- Replacing an OCS by another unit of the same model.
- Duplicating or "clone" units without a PC.

17.2 Clone:

User needs to perform the following to Clone:

1. The 'Clone Unit' can be accessed by going to the 'System Menu' of the OCS. A new menu "Clone Unit" has been added at the end of the main system menu as shown below:

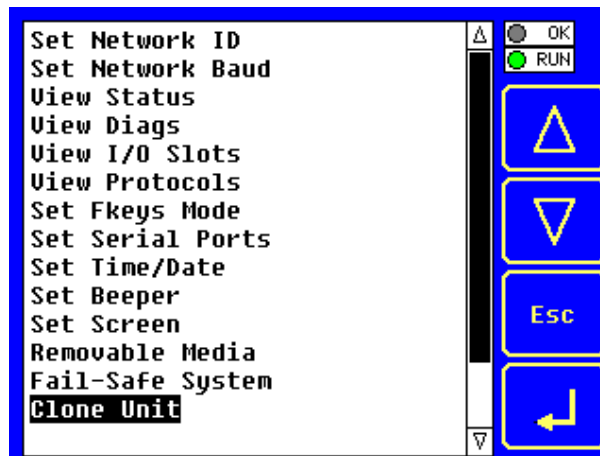

Figure 17.1 – System Menu

2. Selecting "Clone Unit" menu will open the following menu screen:

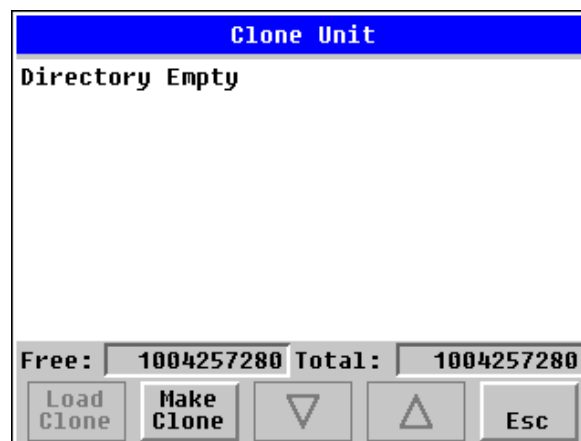

Figure 17.2 – Clone Unit Menu before Cloning

Note:

Free/Total – displays number of free and total bytes in Removable Media.

3. Make/Create Clone option enables user to duplicate / Clone application file, all unit settings and all register values from Battery Backed RAM.

Selecting Make Clone brings up the screen below for the user:

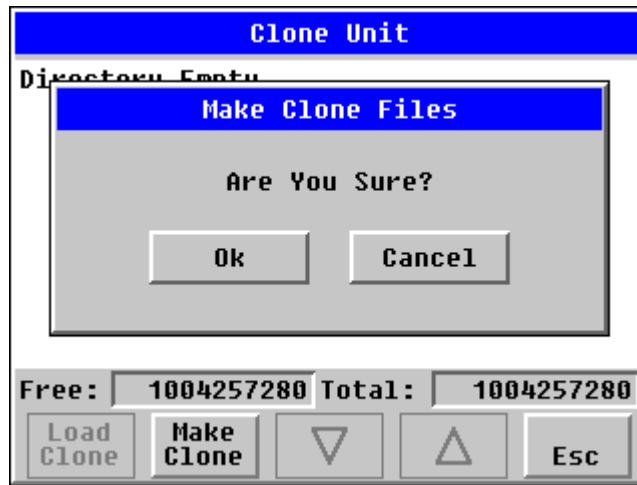

Figure 17.3 – Clone Unit Confirm Screen

After confirmation, the OCS will create two new files in the root directory of the Removable Media Drive as shown below:

AUTOLOAD.PGM
CLONE.DAT

Application file
File having all unit settings and register values from Battery Backed RAM

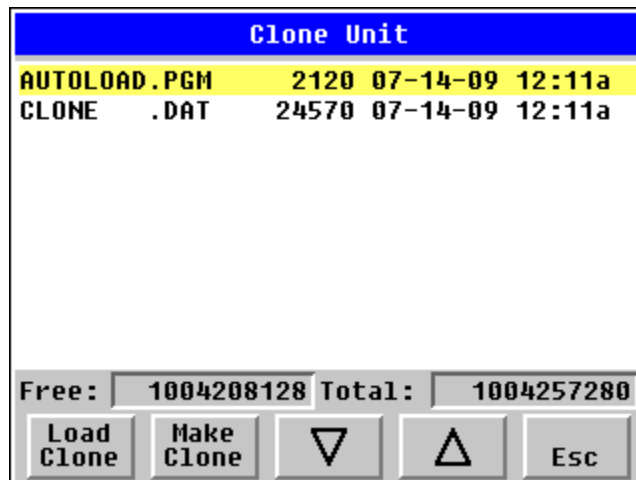

Figure 17.4 – Clone Unit Files

NOTE: Make/Create clone operation automatically includes the security in \AUTOLOAD.PGM file for security enabled files.

4. Once the cloning is successful, OCS gives a message as below:

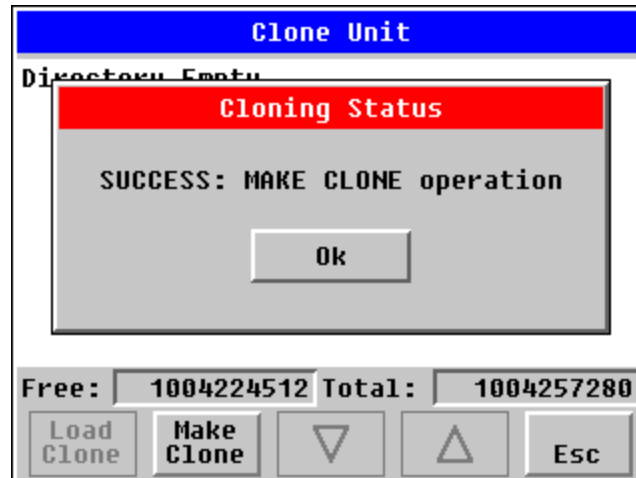

Figure 17.5 – Cloning Status

Make/Create clone can also be triggered by setting %SR164.9 bit to “1” from Ladder program or graphics. Once the operation is completed, this bit is made zero by the firmware. When Make clone operation is triggered by this SR bit, it does not ask the user for confirmation for making clone. The success / failure of the operation is also not notified on screen to the user.

In case of failure of “Make Clone” operation, %SR164.11 bit is set to “1” by the firmware and never reset.

NOTE: Backup of registers in flash memory is not performed by Clone Feature. If user desires, Backup should be done as explained in [Chapter 16](#) (Fail Safe System).

17.3 Load Clone

This option loads the application, all unit settings and register values from Removable media to the Battery backed RAM (Regardless of AutoLoad settings) and then resets the OCS for the settings to take effect.

User needs to perform the following to Load Clone:

1. Select “Clone Unit” from main system menu of OCS as shown below:

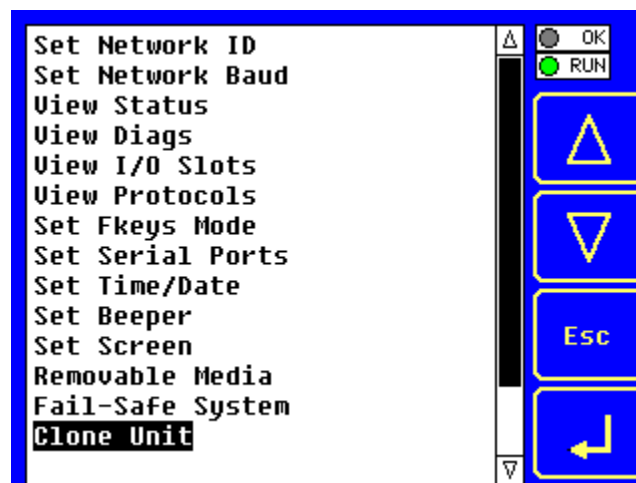

Figure 17.6 – System Menu

2. Selecting “Clone Unit” menu will open the following menu screen. Select “Load Clone”.

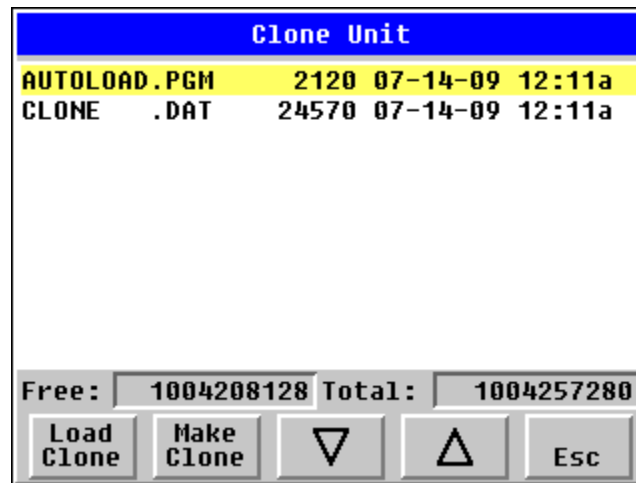

Figure 17.7 – Clone Unit Menu after Cloning

3. User needs to confirm Load Clone as shown below:

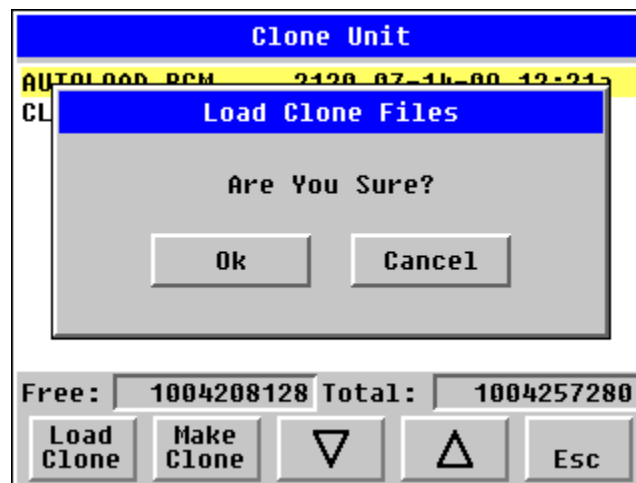

Figure 17.8 – Load Clone Confirm Screen

4. After confirmation, all unit settings and register values will be loaded from Removable media to the Battery backed RAM (Regardless of AutoLoad settings) and then OCS resets for the settings to take effect.

NOTE: For security enabled files, Load clone asks for password validation before loading the application.

Load clone can also be triggered by setting %SR164.10 bit to “1” from Ladder program or graphics. Once the operation is completed, this bit is made zero by the firmware. When Load clone operation is triggered by this SR bit, it does not ask the user for confirmation for loading clone. The success / failure of the operation is also not notified on screen to the user.

In case of failure of “Load Clone” operation, %SR164.12 bit is set to “1” by the firmware and never reset.

CHAPTER 18: MAINTENANCE

18.1 Firmware Updates

The XL4 OCS products contain field updatable firmware to allow new features to be added to the product at a later time. Firmware updates should only be performed when a new feature or correction is required.

Warning: Firmware updates are only performed when the equipment being controlled by the XL4 OCS is in a safe, non-operational state. Communication or hardware failures during the firmware update process can cause the controller to behave erratically resulting in injury or equipment damage. Make sure the functions of the equipment work properly after a firmware update before returning the device to an operational mode.

Steps for updating the firmware:

1. Loading new firmware will erase any program stored in the OCS for safety and compatibility reasons. Please backup the application prior to doing a firmware update.
2. Copy the supplied files onto a FAT32 formatted micro SD or USB based flash device.
3. Insert the flash device into the XL4 making sure no other memory or drives are connected to the device.
4. Press and hold the system menu for at least 6 seconds. You will be presented with a firmware update menu.
5. If you are just updating the firmware, press the "Update Firmware" button. If you are updating the bootloader, firmware and FPGA, press the "Update Bootloader" button. On early versions of firmware this can take several minutes. This will take about 15 seconds on newer firmware.

18.2 Backup Battery

The XL4 has a more advanced battery system. It uses a rechargeable lithium battery. The battery powers the real time clock when power is removed. To store registers, the battery continues to power the OCS for less than a second after external power is removed. In this time the registers and other retentive data is saved to internal flash memory. This battery will need about 8 hours of charging to last approximately 2 years when powered off. Note for the registers to be retentive the battery only need to be charged and present at power down.

Under normal conditions the battery in the XL4 OCS should last 7 years. Higher operating temperatures or variations in batteries may reduce this time.

18.2.1 *Indications the battery needs replacing*

The XL4 OCS indicates the battery is low, failed or missing in a variety of ways. At power-up, an error message is displayed indicating the low or missing battery. The user program can monitor the battery using %SR55.13. This bit will turn on if the battery is low or missing. The system menu also contains a battery status message under the diagnostics sub-menu (see the chapter on System Settings and Adjustments).

18.2.2 Battery Replacement

Warning: Lithium Batteries may explode or catch fire if mistreated
Do not recharge, disassemble, heat above 100 deg.C (212 deg.F) incinerate, or puncture.

Warning: Disposal of lithium batteries must be done in accordance with federal, state, and local regulations. Be sure to consult with the appropriate regulatory agencies *before* disposing batteries. In addition, do not re-charge, disassemble, heat or incinerate lithium batteries.

Warning: Do not make substitutions for the battery. Be sure to only use the authorized part number to replace the battery.

The XL4 OCS uses a lithium ion battery available from Horner APG.

Below are the steps to replace the battery.

1. Make sure the user program and any data stored in retentive memory is backed up.
2. Disconnect all power from the XL4 OCS unit including I/O power.
3. Remove the back cover.
4. Remove the I/O board
5. Remove the tape securing the battery and remove the battery.
6. Dispose of the old battery properly; see the above warning on disposal regulations.
7. Install the new battery
8. Install the I/O board being careful to align the connector pins.
9. Place the back cover back on the unit.
10. Apply power to the unit. Check that the battery error is no longer reported. If the unit still reports the error, remove the battery immediately and contact Technical Support.

CHAPTER 19: TROUBLESHOOTING / TECHNICAL SUPPORT

Chapter 18 provides commonly requested **troubleshooting information and checklists** for the following topics.

- Connecting to the XL4 OCS controller
- Local controller and local I/O
- CsCAN Network
- Removable media

In the event that this information is not what you need, please contact Technical Support at the locations indicated at the end of this chapter.

19.1 Connecting to the XL4 OCS

Cscape connects to the local controller automatically when the serial connection is made. The status bar below shows an example of a successful connection. This status bar is located in the bottom right hand corner of the Cscape window.

Local:253 Target:253(R) [no forces]

In general the **Target** number should match the **Local** number. The exception to this is when the controller is being used as a "pass through" unit where other controllers on a CsCAN network could be accessed through the local controller.

Determine connection status by examining feedback next to **Local & Target** in the status bar of Cscape.

Local: ###	If a number shows next to Local then communication is established to the local controller.
Local: No Port	Cscape is unable to access the COM port of the PC. This could mean that Cscape is configured for a COM port that is not present or that another program has control of the COM port. Only one Cscape window can access a port at a time. Subsequent instances of Cscape opened will indicate No Port.
Local: No Com	Cscape has accessed a PC COM port, but is not communicating with the controller. This typically occurs when the controller is not physically connected.
Local: ???	Unknown communication error. Close Cscape, power cycle the controller and reopen Cscape with a blank project. Check Local.
Target: #(I,R,D)	If I (idle), R (run), or D (do I/O) shows next to Target number then communication is established to the target controller.
Target: #(?)	Communication is not established to the target controller. Check node ID of controller and set Target to match. Make sure local connection is established.

19.1.1 Connecting Troubleshooting Checklist (serial port – MJ1 Programming)

1. Programming and debugging must use MJ1 or USB Mini B Port.
2. Controller must be powered up.
3. Ensure that the correct COM port is selected in Cscope: Tools/Editor Options/Communications Port.
4. Ensure that a straight through (non null modem) serial cable is being used between PC and controller port MJ1.
5. Check that a Loaded Protocol or ladder is not actively using MJ1. Taking the controller out of run mode from the System Menu on the controller will make MJ1 available to Cscope.
6. Make sure the COM port of the PC is functioning. An RS-232 serial loopback and Microsoft HyperTerminal can determine positively if the COM port is working. Or connect to an alternate device to determine if the port is working.
7. Successful communications with USB-to-serial adapters vary. If in doubt, Horner APG offers a USB to serial adapter. Part number HE500USB600.
8. XL4 OCS units without Ethernet must use MJ1 or the Mini B USB Port for programming and debugging. If Ethernet is installed it can be selected as the programming port. The selection is made in the controller's System Menu. If there are difficulties connecting, make sure that the default programming port is set correctly with the connection method being attempted.

19.1.2 Connecting Troubleshooting Checklist (USB Port - Mini B Programming)

1. Programming and debugging must use Mini B USB Port or MJ1.
2. Controller must be powered up.
3. Ensure that the correct COM port is selected in Cscope: Tools/Editor Options/Communications Port
4. Be sure that the USB cable is connected between the PC and controller and check the Windows Device Manager to find out if the USB driver is properly installed and which port it set itself up on..
5. Make sure the USB port of the PC is functioning and/or connect to an alternate device to determine if the port is working.
6. XL4 OCS units without Ethernet must use the Mini B USB Port or MJ1 for programming and debugging. If Ethernet is installed it can be selected as the programming port. The selection is made in the controller's System Menu. If there are difficulties connecting, make sure that the default programming port is set correctly with the connection method being attempted.

19.1.3 Connecting Troubleshooting Checklist (ETN port programming)

1. Programming and debugging must use MJ1 or Ethernet Port.
2. Controller must be powered up.
3. Ensure that correct IP address is given in the Ethernet field and correct Mode is selected, in Cscope: Tools/Editor Options/Communications Port
4. Ensure that the Ethernet Cable is connected between the controller and the Ethernet Hub.
5. Make sure the Ethernet cable is functioning properly.

19.2 Local Controller and Local I/O

The system menu provides the following status indications that are useful for troubleshooting and system maintenance.

- Self-test results, diagnostics.
- RUN and OK status
- Network status and usage
- Average logic scan rate
- Application memory usage
- Loaded firmware versions

- Loaded protocols
- Removable media access

To view the system menu, press the System key.



19.2.1 Local I/O Troubleshooting Checklist

1. Verify the controller is in RUN mode.
2. Check diagnostics to insure controller passed self-tests.
View diags in System Menu or in Cscape, click; Controller/Diagnostics
3. Check data sheets to insure proper wiring.
4. Insure that hardware jumpers and software configuration for I/O match.
5. Check data sheets for voltage and current limits.
6. Take ladder out of the picture. From Cscape set controller to "Do I/O" mode. In this mode inputs can be monitored and outputs set from a data watch window in Cscape without interference from the ladder program. Some I/O problems are only a result of a mistake in the ladder program.

WARNING: Setting outputs ON in Do I/O mode can result in injury or cause machinery to engage in an unsafe manner depending on the application and the environment.

19.3 CsCAN Network

For complete information on setting up a CsCAN network, refer to CAN Networks manual (MAN0799) by visiting our website for the address to obtain documentation and updates.

Network status, node ID, errors, and baud rate in the controller system menu are all in reference to the CsCAN network. These indications can provide performance feedback on the CsCAN network and can also be used to aid in troubleshooting.

19.3.1 CsCAN Network Troubleshooting Checklist

1. Use the proper Belden wire type or equivalent for the network as specified in MAN0799.
2. The XL4 OCS does not provide 24VDC to the network. An external voltage source must be used for other devices such as SmartStix I/O.
3. Check voltage at both ends of the network to insure that voltage meets specifications of attached devices.
4. Proper termination is required. Use 121-ohm (or 120-ohm) resistors at each end of the network. The resistors should be placed across the CAN_HI and CAN_LO terminals.
5. Measure the resistance between CAN_HI and CAN_LO. If the network is properly wired and terminated there should be around 60 ohms.
6. Check for duplicate node ID's.
7. Keep proper wires together. One twisted pair is for V+ and V- and the other twisted pair is used for CAN_HI and CAN_LO.
8. Make sure the baud rate is the same for all controllers on the network.
9. Assure shields are connected at one end of each segment -- they are not continuous through the network.
10. Do not exceed the maximum length determined by the baud rate and cable type.
11. Total drop length for each drop should not exceed 6m (20 feet). A drop may include more than one node. The drop length adds to the overall network length.
12. Network should be wired in "straight line" fashion, not in a "star" pattern.
13. In applications requiring multiple power supplies, make sure the V- of all supplies is connected together and to earth ground at one place only.

14. In some electrically noisy environments it may be necessary to add repeaters to the network. Repeaters can be used to add additional nodes and/or distance to the network and protect the signal against noisy environments. The Horner APG repeater is part # HE200CGM100.

19.4 Removable Media

19.4.1 Basic Troubleshooting

Description	Action
XL4 OCS does not read media card.	The media card should be formatted with the XL4 OCS.
XL4 OCS will not download project file.	Make sure the project file is saved as a .pgm file and not a .csp file. In addition to file must be .pgm, the file's I/O configuration must match the XL4 configuration for it to download.

19.5 Technical Support Contacts

For manual updates and assistance, contact Technical Support at the following locations:

North America:

Tel: (317) 916-4274

Fax: (317) 639-4279

www.heapg.com

Email: techsppt@heapg.com

Europe:

Tel: (+) 353-21-4321-266

Fax: (+353)-21-4321826

www.horner-apg.com

Email: tech.support@horerapg.com

Index

- %Q bits, 44
- Accessories**, 15
- accumulator, 50, 51, 52
- Analog Inputs**, 46
- Analog Outputs**, 47
- AutoLoad, 106
- AutoRun, 108
- Backup / Restore, 102
- Battery**
 - Backup**, 113
 - Replacement, 114
 - Warnings, 114
 - When to Replace, 113
- Battery backed RAM, 70, 109
- CAN Comm**
 - Cscape Programming**, 28
 - I/O Expansion (Network I/O), 28
 - Ladder-Controlled**, 28
 - Overview**, 27
 - Ports**, 27
 - Wiring**, 28
- CAN Communications, 27
- CE, 12
- Clone Unit, 70, 109
- CLONE.DAT**, 71, 110
- COM, 25, 26, 28, 35, 36, 63, 64, 65, 84, 115, 116
- COM port, 94, 115, 116
- Communicating via MJ1 Serial Port**, 95
- Communication options**, 29, 35
 - Modem COM Module (XMC)**, 36
 - Overview**, 35
- Communications Port, 94, 116
- Compliance**
 - CE**, 12
- Count, 54, 55, 57, 58
- Cscape Program**
 - Via Serial Port**, 26
- Cscape, 2, 15, 25, 26, 27, 28, 36, 38, 39, 41, 44, 46, 47, 49, 63, 64, 77, 86, 89, 90, 95, 115, 116, 117
 - Analog In Configuration**, 99
 - Analog Out Configuration**, 100
 - Configuration Procedures**, 97
 - Digital In / HSC Configuration**, 97
 - Digital Out / PWM Configuration**, 98
 - Establishing Communications, 90
 - Overview**, 89
 - Status Bar**, 89
- CSCAPE CONFIGURATION**, 89
- datasheet, 9, 41, 46, 47
- Default Gateway, 31
- Device Manager, 116
- Devices to Connect to XL6**, 14
- Digital Inputs**, 46
- Dimensions**, 19
- Duty Cycle, 56, 57
- Duty Cycle Examples**, 57
- ELECTRICAL INSTALLATION**, 23
- Ethernet, 84, 90, 116
- Ethernet Communication, 29
- Ethernet Module
 - Default Gateway, 31
 - IP Address, 31
 - Net Mask, 31
 - Status Register, 31
 - Version Register, 32
- Ethernet Module Configuration, 29
- Ethernet Module Protocol Configuration**, 33
- Ethernet Module Protocols and Features, 29
- Ethernet Module Specifications, 29
- Ethernet System Requirements, 29
- Fail Safe System Overview, 101
- Fail Safe System Settings, 102
- Features**, 14
- Firmware Updates**, 113
- Frequency, 50, 53, 55, 56, 57, 58, 98
- Front Panel and USB Programming Connector, 90
- fusing, 44, 45
- GENERAL I/O**, 41
 - Overview**, 41
- Glossary, High Speed I/O**, 49
- Ground Specification, 23
- Grounding**
 - Locations of Information**, 12
- Grounding Definition**, 23
- High Speed**
 - Configure Inputs**, 50
 - Frequency, 50
- High Speed / PWM**
 - Overview**, 49
- High Speed Counting, 49
- HIGH SPEED I/O**, 49
- HSC, 49, 50, 51, 52, 53, 54, 55, 97
- I/O Cover Removal**, 41
- IP Address, 31
- Jumpers Example, 42
- LIMITED WARRANTY**, 3
- Load Clone**, 71, 111
- Maintenance**, 109, 113
- Make Clone, 109
- Manual Index, 14
- Mechanical installation**, 17
- Micro SD Cards**, 37
 - Installing / Removing**, 37
- Micro SD System, 38

- Minimum Clearance Requirements for Panel Box and Door, 20
- MJ Serial Port Connectors Photograph, 25
- Model / I/O Overview**, 42
- Modem COM Module Option**, 36
- Mounting Orientation**, 18
- Mounting Requirements**, 17
 - Panel Door Mounting, 17
- Net Mask, 31
- OCS Reference Document Numbers, 16
- Orientation of XL6 OCS**, 18
- Panel Box
 - Clearances, 20
 - Grounding, 20
 - Noise, 21
 - Orientation, 21
 - Temperature, 20
- Panel Box Shock and Vibration, 21
- Panel Cut-out**, 19
- Panel Cutout Tolerances**, 19
- Panel Design Checklist, 21
- Panel Layout / Clearances**, 20
- Panel Mounting of an XL6 Series OCS**, 17
- Power Connector (Primary Power Port)**, 24
- Primary Power Port, 24
- Primary Power Port As Viewed Looking at the XL6 OCS**, 24
- Primary Power Port Pins, 24
- PROGRAMMING EXAMPLES**, 3
- Pulse, 50, 51
- pulse mode, 50, 51
- pulse stream, 50, 51
- Pulse Width Modulation, 49, 54
- PWM, 15, 44, 49, 54, 56, 57, 97, 98, 99
 - Examples**, 57
 - Frequency Formula, 55
 - Registers**, 56
- Quadrature, 50, 51, 52, 98
- References / Useful documents**, 16
- register mapping, 41, 44
- registers**, 83
 - %S / %SR**, 84
 - Definitions**, 83
 - I/O**, 87
 - Resource Limits**, 87
- Relay Outputs**, 44
- REMOVABLE MEDIA**, 37
 - Load / Save Applications, 39
 - Log Data**, 38
 - Overview**, 37
 - Save Applications XL6, 39
 - View / Capture, 39
- Removable Media Manager**, 38
- Removable Media Manager Submenu**, 38
- Removable Media XL6, 67
- Removable Memory Card Slot Photograph**, 37
- RS-485 Biasing**, 25
- RS-485 Termination**, 25
- safety / compliance**, 11
- Safety Warnings, Guidelines**, 11
- Serial Comm**
 - Cscape Programming**, 26
 - Downloadable Protocols**, 26
 - Ladder-Controlled**, 26
 - Overview**, 25
 - Ports**, 25
 - Wiring**, 25
- SERIAL COMMUNICATIONS**, 25
- Set Network ID**, 61, 95, 96
- Solid-State Digital Outputs**, 44
 - sourcing*, 44, 46
 - stepper, 49, 55, 56
 - stop state, 44, 46
- Sub-Menus**, 59
- System Menu**, 59
 - Details**, 61, 72
 - Navigate / Edit**, 60
- System Menu (XL6) Screenshot**, 60
- SYSTEM SETTINGS AND ADJUSTMENTS**, 59
- Sytem Menu**
 - Overview**, 59
- Table of Contents**, 5
- target ID, 95, 96
- target indicator, 95, 96
- Technical Support**, 2, 16, 46, 114, 115, 118
 - Contacts**, 118
- Testing for Good Ground**, 23
- Totalize, 50
- Troubleshooting**
 - Common problems**, 115
 - Connecting Checklist**, 116
 - CsCAN Checklist*, 117
 - CsCAN Network**, 117
 - Local Controller / I/O**, 116
 - Local I/O Checklist, 117
 - Removable Media**, 118
 - troubleshooting / technical support**, 115
- Troubleshooting Checklist (serial port – MJ1) Programming**, 116
 - Troubleshooting Checklist (USB Port - Mini B) Programming*, 116
- Troubleshooting Checklist (Ethernet port Programming) [For XL6e only]**, 116
- Two-Point Ground Connection Test**, 23
- Types of Devices that can be connected to XL6**, 14
- Universal Analog Inputs**, 47
- USB, 15, 28, 90, 116
- USER INTERFACE**, 73
 - Ladder Based Navigation**, 76

Screen Navigation, 76
Using Removable Media to View and Capture
Screens, 39
Visual Overview of XL6 and Topics, 13
Where to Find Information, 13
XL6 Dimensions, 19
XL6 I/O Cover Photograph, 42
XL6 I/O Cover Removed (sample I/O board)
Photograph, 42

XL6 Manual PREFACE, 2
XL6 OCS Accessories, 15
XL6 OCS Dimensions, 19
XL6 OCS Mounting Clip, 18
XL6 OCS Mounting Orientation, 18
XL6 OCS with Mounting Clips, 18
XMC, 36

Table of Figures

Figure 2.3 – Visual Overview of Types of Devices that can be connected to XL4 OCS	14
Figure 3.1 – Panel Mounting of an XL4 Series OCS	17
Figure 3.2 – XL4 OCS with Mounting Clips	18
Figure 3.3 – Orientation of XL4 OCS	18
Figure 3.4 – Panel Cutout Tolerances	19
Figure 3.5 – XL4 OCS Dimensions	19
Figure 4.1 – Two-Point Ground Connection Test	23
Figure 4.2 – Power Connector (Primary Power Port)	24
Figure 4.3 – Primary Power Port as Viewed Looking at the XL4 OCS	24
Figure 6.1 – CAN1 Connector	27
Figure 6.2 – CAN1 Port Connector	28
Figure 7.1 – I/O Configuration Dialog	30
Figure 7.2 – Ethernet Module Configuration	31
Figure 9.1 – Removable Micro SD Memory Card Slot	37
Figure 9.2 – Installing Removable Memory Card	37
Table 8.1 – Filename Special Symbols	40
Table 8.2 – RM Status Values	40
Figure 10.1 – Removing the I/O Cover	41
Figure 10.4 – Example Jumper Diagram	42
Figure 10.5 – Typical Output Wiring	44
Figure 10.7 – Positive and Negative Inputs	46
Figure 12.1 – System Menu	59
Figure 13.1 – Example Screen (XL4 only)	73
Figure 13.2 – Alpha-numeric Keypad and ASCII Keypad	75
Figure 13.3 – Typical Screen Jump Object (XL4)	76
Figure 13.4 – Force and Switch Coils in Ladder Programming	77
Figure 13.3 – Alarm Object	78
Figure 13.4 – Alarm Viewer	78
Figure 13.5 – Removable Media Object	79
Figure 13.6 – Removable media viewer	79
Figure 13.7 – Example application segment for safe removal of removable media	80
Figure 15.1 – USB Programming Connector	90
Figure 15.2 – Digital Input / HSC Configuration Dialog	97
Figure 15.3 – Digital Output / PWM Configuration Dialog	98
Figure 15.4 – Analog Input Configuration Dialog	99
Figure 15.5 – Analog Output Configuration Dialog	100
Figure 16.1 – Fail – Safe System Menu	101
Figure 16.2 – Backup / Restore Data	102
Figure 16.3 – Backup Registers	103
Figure 16.4 – Restore OCS Data	103
Figure 16.5 – Clear Backup Data	104
Figure 16.6 – Flow Chart for Automatic Restore	105
Figure 16.7 – AutoLoad Menu	106
Figure 16.8 – Flow Chart for AutoLoad	107
Figure 16.9 – AutoRun Menu	108
Figure 17.1 – System Menu	109
Figure 17.2 – Clone Unit Menu before Cloning	109
Figure 17.3 – Clone Unit Confirm Screen	110
Figure 17.4 – Clone Unit Files	110
Figure 17.5 – Cloning Status	111
Figure 17.6 – System Menu	111
Figure 17.7 – Clone Unit Menu after Cloning	112
Figure 17.8 – Load Clone Confirm Screen	112

<p>No part of this publication may be reproduced without the prior agreement and written permission of Horner APG, Inc. Information in this document is subject to change without notice.</p>
